

500 Series

L500LA | L500LMA

HYUNDAI WIA Heavy Duty CNC Turning Center

Technical Leader

The CNC Turning Center L500 Series, designed by Hyundai WIA with years of expertise and the latest technology, is a Turning Center that maximizes productivity and performance.

		L500LA	L500LMA
Max. Turning Dia.	mm(in)	Ø720 (Ø28.3")	Ø690 (Ø27.2")
Max. Turning Length	mm(in)	2,109 (83")	2,100 (82.7")
Chuck Size	inch	21" [Big Bore : 24"]	
Bar Capacity	mm(in)	Ø165 (Ø6.5")	
Sp. Speed	r/min	21" : 1,500 [24" : 1,000]	
Sp. Motor (Max./Cont.)	kW(HP)	45/37 (60/50)	
Travel (X/Z)	mm(in)	400/2,210 (15.7"/87")	
No. of Tools	EA	10	BMT75 : 12

[] : Option

500 Series

Heavy-Duty Cutting, Large Work Capacity, CNC Turning Center

- High rigidity achieved through box guideways
- One-piece structure for high accuracy and sturdiness
- Enhanced productivity by incorporating Absolute Motor Encoder
- Main spindle heat displacement minimized
- 30° Slanted Bed Structure
- Stabilized long shaft process with the rear chuck option



01 BASIC STRUCTURE

High Rigid Bed & Structure for Heavy Duty Cutting CNC Turning Center

High Precision Spindle

- L500 Series (21") : 1,500 r/min
- Opt. Big Bore (24") : 1,000 r/min
- Big Bore : $\varnothing 275$ mm (Opt.)
- C-Axis Control : 0.001° ('M' Type)

Servo Turret

- No. of Tools
- L500LA : 10 EA
- L500LMA : 12 EA (BMT75)
- Tool Size (O.D/I.D)
- L500LA : $\varnothing 32/\varnothing 80$ ($\varnothing 1\ 1/4"/\varnothing 3"$)
- L500LMA : $\varnothing 32/\varnothing 63$ ($\varnothing 1\ 1/4"/\varnothing 2\ 1/2"$)

2-step Gear Box

Built-in Tail Stock

- Taper : MT#5
- Quill Travel : 132 mm (5.2")

L500LMA

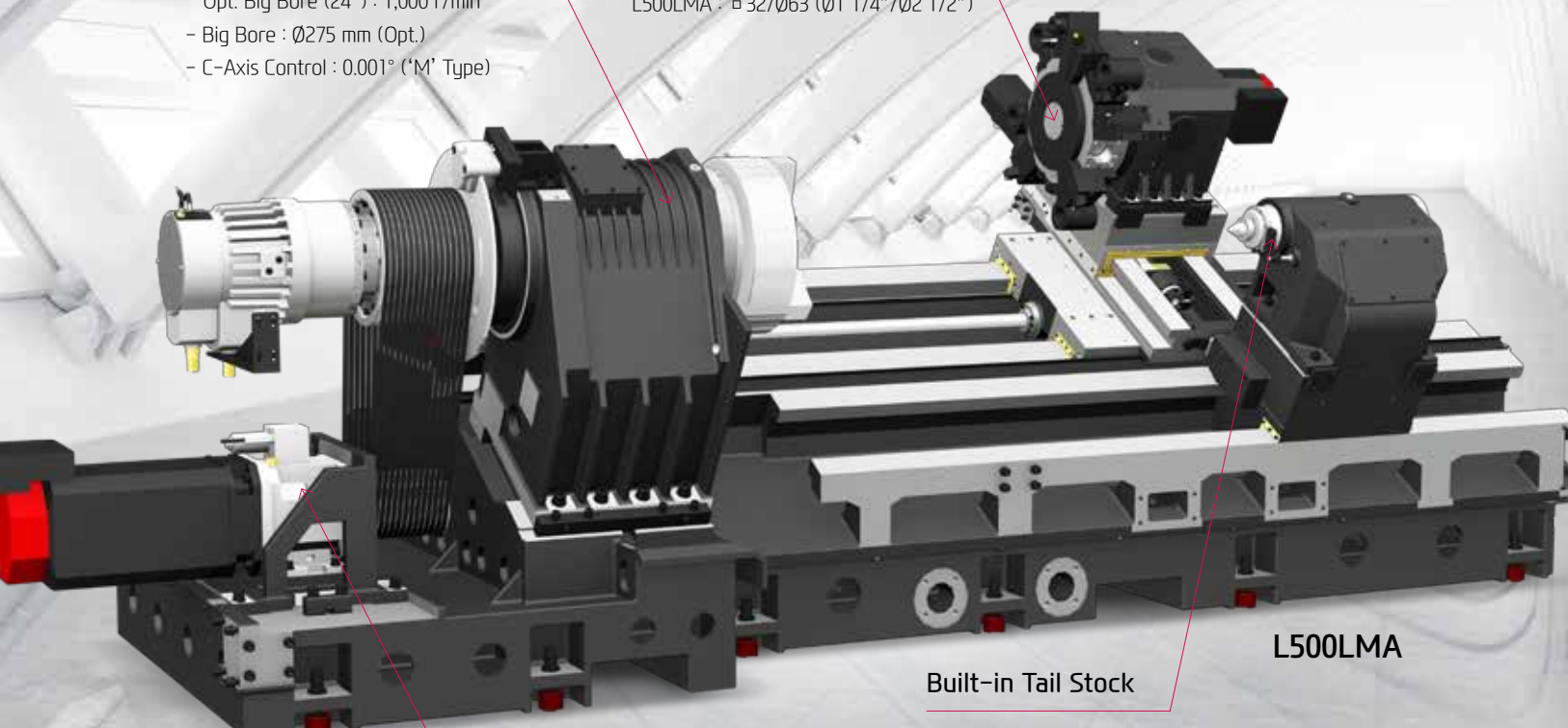

POWERFUL CUTTING CAPABILITY & WIDE CUTTING AREA

ALL-IN-ONE TYPE OF BED

High Precision & Rigidity, One-Piece Structure

Designed with FEM(Finite Element Method) analysis, the L500 Series has bed structure of 30° slope to improve machining accuracy and cutting ability.

In addition, increased bed installation area improves vibration absorption and machining stability.

30° Slanted Bed



The Installation area **40% ↑** 6,420×2,779 mm
(12.8"/47.4")

GUIDEWAY

Box Guideway

All axes of L500 Series are designed with Box Guideways for better travel ability. Box Guideways show great performance in offsetting vibrations caused by heavy duty cutting.



X-Axis Guideway

Expanded guideways for high precision and enhanced heavy duty cutting ability.

Compared to Existing Model : **21% expanded**

L500LMA

Existing Model

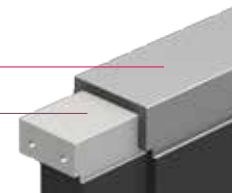

Travel (X/Z)

400/2,210 mm (15.7"/87")

Rapid Traverse Rate (X/Z)

20/18 m/min (787/709 ipm)

02 HIGH PRECISION SPINDLE

Long Lasting, High Accuracy & Excellent Performance CNC Turning Center

Spindle Specifications

MODEL	Spindle Speed	Motor (Max./Cont.)	Torque (Max./Cont.)	Driving Method
L500LA	1,500 rpm (21")	45/37 kW (60/50 HP)	4,112/3,382 N·m (3,032.9/2,494.4 lbf·ft)	■ : Standard Belt + 2 Step Gear
	1,000 rpm (Big Bore 24")	45/37 kW (60/50 HP)	4,486/3,689 N·m (3,308.7/2,720.9 lbf·ft)	
L500LMA	1,500 rpm (21")	45/37 kW (60/50 HP)	2,990/2,459 N·m (2,205.3/1,813.6 lbf·ft)	
	1,000 rpm (Big Bore 24")	45/37 kW (60/50 HP)	4,486/3,689 N·m (3,308.7/2,720.9 lbf·ft)	

HEAVY DUTY CUTTING & HIGH ACCURACY

MAIN SPINDLE

Spindle Ideal for Heavy Cutting

To accomplish advanced stability during heavy duty cutting, a combination of P4 double cylindrical roller bearings and angular bearings are adopted.

The double locking device separates the spindle bearing and pulley to prevent a decrease in spindle bearing pretension during interrupted cutting, heavy duty cutting, chuck cylinder operations, and by belt pulley tension.

2 Step Gear Box

A two-step driving method is applied inside the main spindle as standard on non mill turrets. It provides powerful torque at low speeds and stable rotation at high speeds.

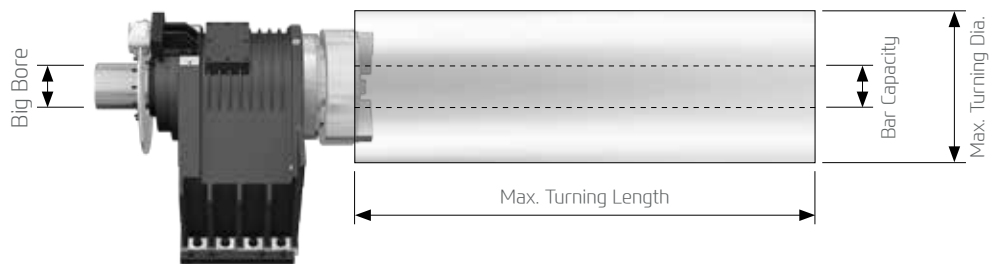

unit : mm(in)

Model	Max. Turning Length	Max. Turning Dia.	Bar Capacity	Big Bore
L500LA	2,109 mm (83")	Ø720 mm (Ø28.3")	Ø165 mm (Ø6.5")	Ø181 mm (Ø7.1")
L500LMA	2,100 mm (82.7")	Ø690 mm (Ø27.2")		[Ø275 mm (Ø10.8")]

C-Axis Control ('M' Type)

The C-axis is capable of 0.001° control when milling turret is applied. Machining capability is strengthened with turning and milling operations.

BIG BORE SPINDLE

OPTION

Spindle bore of Ø181(Ø7.1") [Opt. : Ø275mm(Ø10.8")] shows superior ability in pipe machining. Furthermore, its torque of 4,486 N·m outperforms all others in the the same class.

(L500LMA : 2,990 N·m)



03 SERVO TURRET

High speed, High Accuracy, Highly Reliable Servo Turret

Servo Turret

No. of Tools

10_{EA}

Tool Size (O.D./i.D)

□ 32/Ø80 mm (Ø1 1/4"/Ø3")

Indexing Time

0.35_{sec}

Mill Turret

ITEM	Speed	Motor (Max./Cont)	Torque (Max./Cont)	Collet Size
BMT75	4,000 rpm (FANUC)	11/7.5 kW (15/10 HP)	140/95.4 N·m (103.2/70.4 lbf·ft)	Ø26 (Ø1")/ER40

VARIOUS DRIVEN PRECISION BMT TOOL HOLDERS

SERVO TURRET

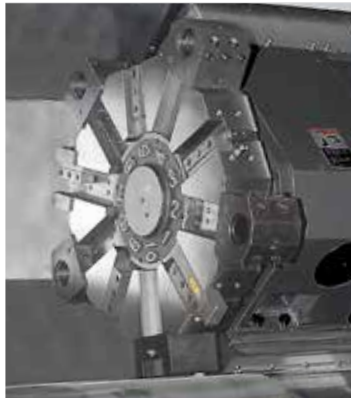

Servo Turret

The L500 Series apply an AC Servo Motor to enhance machining reliability. Also, split accuracy is improved by using 3-piece couplings. Powerful hydraulic tool clamping system minimizes tool tip displacement caused by workload.

High Pressure Coolant **OPTION**

Turret is designed to utilize 20 bar (290 psi) high pressure coolant and it shows optimum performance in machining difficult-to-cut material.



MILL TURRET

BMT75 Turret

The BMT turret secures the tool with four bolts and key on the tool mounting surface of the turret, making it possible to powerfully fix the tool, ensuring high reliability in rigidity and precision.

STRAIGHT MILLING HEAD



ANGULAR MILLING HEAD



Mill Tool Holder

Machining capability has increased with the addition of straight milling head tool holder, which can machine workpieces from the side, and angular milling head tool holder, which can perform I.D. operations.

04 USER CONVENIENCE

Various Devices for User Friendly

TAIL STOCK

Built-In Tail Stock

The built-in tail stock ensures high accuracy even during heavy duty cutting and can be controlled automatically or manually.

Taper	Quill Dia.	Quill Travel	Travel
MT#5	Ø150 mm (Ø5.9")	132 mm (5.2")	2,083 mm (82")



TURNING SUPPORT SYSTEM



Auto Q-Setter

Quick and accurate tool calibration can be done by contacting the tool tip with the sensor.



Steady Rest **OPTION**

For long parts, such as shafts, the steady rest increases rigidity and minimizes vibration.

(Manual/Programmable hydraulic steady rest)



Rear Chuck **OPTION**

The rear chuck option enables long products such as long shaft or pipes to be processed in a stable condition.

※ Big Bore option: Detachable Q-setter (24"~32" chuck size) / Automatic Q-setter (24" chuck size)



Auto Door **OPTION**

The door can be automatically open/closed with the use of M-Code. This function enables automation system and improves efficiency.

Optional

CHIP DISPOSAL SOLUTION

Chip Conveyor

Timely and effective disposal of chips will enhance productivity as well as the working environment.



Hinge	Chip Type : Roughing Chip, Long Chip, Chip complex	Material : SS41, 45C, Cast Steel	Front Right Direction
	Highly efficient when disposing a lot of chips. Capable of handling stringy chips..		
Scraper	Chip Type : Finely broken chip blown out	Material : cast Iron, Nonferrous	
	Convenient for shortly cut chips.		
❖ Screw	Chip Type : The lower portion of micro-chips	Material : Steel, Casting	
	Compresses and ejects chips to reduce chip Trouble.		
❖ Drum Filter	Chip Type : Powder, Micro Chip	Material : AL	
	Advantageous in precision, as the chips do not flow in to the coolant nozzle.		

❖ When ordering a screw or drum filter chip conveyor, prior consult with hyundai wia's sales person.

COOLANT UNIT & ECO SYSTEM



Standard Coolant (Nozzle)



Chuck Coolant (Upper Chuck)



Chuck Air Blow (Upper Chuck)



Air Gun

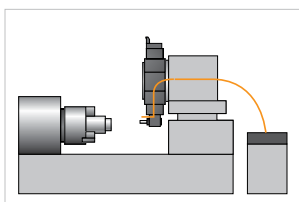

MQL : Minimal Quantity Lubrication



Oil Skimmer



Mist Collector



Grease Lubrication Device

SPECIFICATIONS

Standard & Optional

Spindle		L500LA	L500LMA
Main Spindle	21"	●	●
Hollow Chuck 3 Jaw	24"	○	○
Main Spindle	21"	-	-
Solid Chuck 3 Jaw	24"	-	-
Big Bore	Ø275mm(Ø10.8")	○	○
Rear Chuck		○	○
Standard Soft Jaw (1set)		●	●
Chuck Clamp Foot Switch		●	●
2 Steps Hyd. Pressure Device		○	○
Spindle Inside Stopper		☆	☆
Main Spindle 5" Index		-	-
C-axis (0.001")		-	●
Cs contouring function		-	☆
Chuck Open/Close Confirmation Device		○ (CE:●)	○ (CE:●)
2 Steps Chuck Foot Switch		☆	☆
Turret			
Tool Holder		●	●
10 station Turret		●	-
12 station Turret		-	●
Mill Turret	BMT	-	●
Straight Milling Head (Radial)	Collet Type,1ea	-	●
Angular Milling Head (Axial)	Collet Type,1ea	-	●
Straight Milling Head (Radial)	Adapter Type	-	-
Angular Milling Head (Axial)	Adapter Type	-	-
Boring Sleeve		●	●
Drill Socket		●	●
U-Drill Holder		○	○
U-Drill Holder Sleeve		○	○
Extension Holder	For Out-Dia	●	-
Angle Head		☆	☆
Tail Stock & Steady Rest			
Built-In Tail Stock		●	●
Programmable Tail Stock (MT #5)		●	●
Manual Type Steady Rest		☆	☆
Manual Type Hyd. Steady Rest		○	○
Programmable Hyd. Steady Rest		○	○
Standard Dead Center		●	●
2 Steps Tail Stock Pressure System		☆	☆
Quill Forward/Reverse Confirmation Device		○ (CE:●)	○ (CE:●)
Tail Stock Foot Switch		○	○
Coolant & Air Blow			
Standard Coolant (Nozzle)		●	●
Chuck Coolant (Upper Chuck)		☆	☆
Gun Coolant		○	○
Through Spindle Coolant (Only for Special Chuck)		☆	☆
Thru Coolant for Live Tool		-	-
Chuck Air Blow(Upper Chuck)		○	○
Tail Stock Air Blow (Upper Tail Stock)		☆	☆
Turret Air Blow		☆	☆
Air Gun		○	○
Through Spindle Air Blow (Only for Special Chuck)		☆	☆
High Pressure Coolant	6Bar (87psi)	●	●
	20Bar (290psi)	○	○
	70Bar (1,015psi)	○	○
Power Coolant System (For Automation)		☆	☆
Coolant Chiller		☆	☆
Chip Disposal			
Coolant Tank	400 ℓ (105.7 gal)	-	-
	500 ℓ (132 gal)	●	●
Chip Conveyor (Hinge/Scraper)	Front (Right)	○	○
	Front (Rear)	-	-
Special Chip Conveyor (Drum Filter)		☆	☆
ETC			
Tool Box		●	●
Customized Color	Need Munsel No.	☆	☆
CAD & CAM		☆	☆

● : Standard ○ : Option ☆ : Prior Consultation - : Non Applicable

Chip Wagon	Standard (180 ℓ [47.5 gal])	○	○
	Swing (200 ℓ [52.8 gal])	○	○
	Large Swing (290 ℓ [76.6 gal])	○	○
	Large Size (330 ℓ [87.2 gal])	○	○
	Customized	☆	☆
Safety Device			
Total Splash Guard		●	●
Chuck hydraulic pressure maintenance interlock		○ (CE:●)	○ (CE:●)
Electric Device			
Call Light	1Color : ●	●	●
Call Light & Buzzer	3Color : ●●● B	○	○
Electric Cabinet Light		○	○
Remote MPG		○	○
Workcounter	Digital	○	○
Totalcounter	Digital	○	○
Toolcounter	Digital	○	○
Multi-Toolcounter	Digital	○	○
Electric Circuit Breaker		○	○
AVR (Auto Voltage Regulator)		☆	☆
Transformer	50kVA	-	-
	60kVA	○	○
Auto Power Off		○	○
Measurement			
Q-Setter		- (Big Bore : ○)	- (Big Bore : ○)
Automatic Q-Setter		● (Big Bore : ○)	● (Big Bore : ○)
Work Close Confirmation Device (Only for Special Chuck)	TACO	☆	☆
	SMC	☆	☆
Work Setter		☆	☆
Linear Scale	X Axis	○	○
	Z Axis	○	○
Coolant Level Sensor (Only for Chip Conveyor)		☆	☆
Environment			
Air Conditioner		○	○
Oil Mist Collector		☆	☆
Oil Skimmer (Only for Chip Conveyor)		○	○
MLQ (Minimal Quantity Lubrication)		☆	☆
Fixture & Automation			
Auto Door	High Speed	○	○
Auto Shutter (Only for Automatic System)		-	-
Sub Operation Pannel		☆	☆
Bar Feeder Interface		○	○
Bar Feeder (FEDEK)		☆	☆
Extra M-Code 4ea		○	○
Automation Interface		☆	☆
I/O Extension (IN & OUT)	16 Contact	○	○
	32 Contact	○	○
Parts Catcher		-	-
Turret Work Pusher (For Automation)		☆	☆
Hyd. Device			
Standard Hyd. Cylinder	Hollow	●	●
Standard Hyd. Unit	60bar(870psi) / 13 ℓ (3.4gal)	-	-
	60bar(870psi) / 20 ℓ (5.3gal)	●	●
S/W			
Machine Guidance (HW-MCG)		●	●
Energy Saving System (HW-ESS)		●	●
Tool Monitoring (HW-TM)		○	○
Spindle Heat Distortion Compensation(HW-TDC)		○	○
DNC software (HW-eDNC)		○	○
Machine Monitoring System (HW-MMS)		○	○
Conversational program (HW-DPRO)		○	○

❖ 4 channel of TDC(Thermal Displacement Compensation) device is recommended, when more than 6 bar of high pressure coolant is applied, for the high quality machining.

Prior consultation is required when applying spindle contouring control for gear driven spindle. / Specifications are subject to change without notice for improvement.

SPECIFICATIONS

Spindle Output/Torque Diagram

L500LA 1,500 rpm

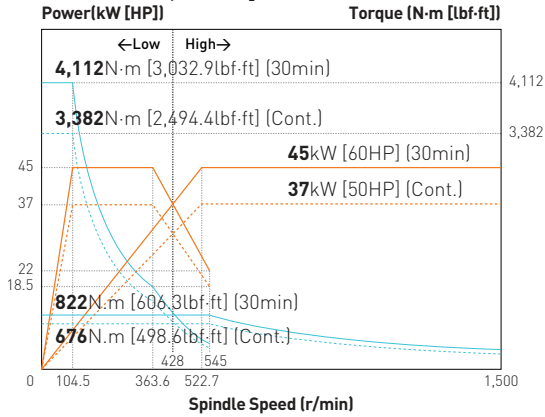

L500LMA 1,500 rpm

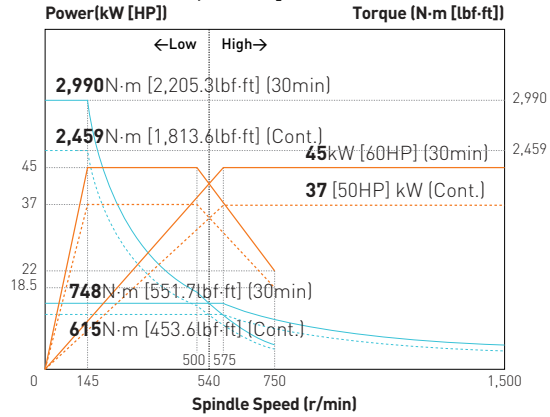

L500 Series 1,000 rpm (Big Bore)

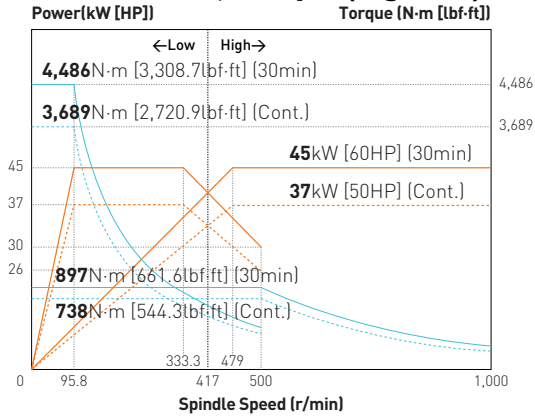

Mill Spindle 4,000 rpm

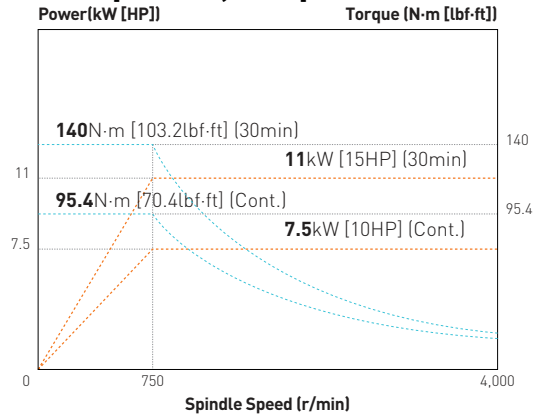

External Dimensions

unit : mm(in)

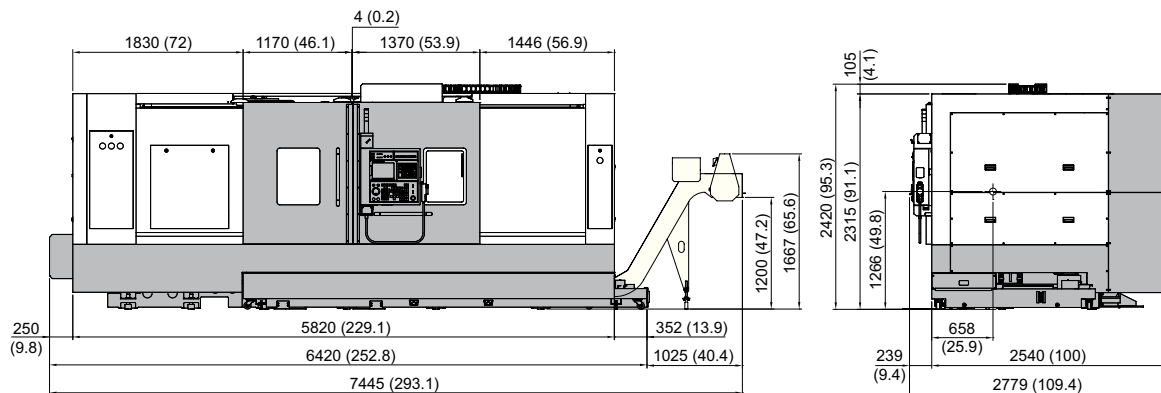

SPECIFICATIONS

Tooling System

unit : mm(in)

L500LA

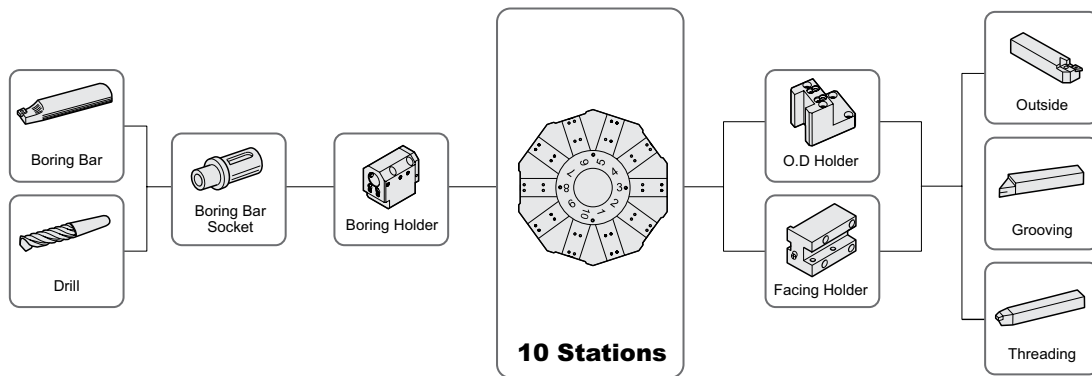

Tooling Parts Detail

ITEM			L500LA		
			mm Unit	inch Unit	
Turning Holder	O.D Holder	Right/Left	1	1	
	Facing Holder		1	1	
Boring Holder	I.D Holder	Single	4	4	
	U-Drill Holder	Tool Holder	Opt	Opt	
Driven Holder	Straight Mill Holder	Standard	-	-	
	Angular Mill Holder	Standard	-	-	
Socket	Boring	Ø20 (Ø3/4")	1	1	
		Ø25 (Ø1")	1	1	
		Ø32 (Ø1 1/4")	1	1	
		Ø40 (Ø1 1/2")	1	1	
		Ø50 (Ø2")	1	1	
		Ø60	1	-	
		Ø2 1/4"	-	1	
	Drill	MT 3		Opt	Opt
		MT 4		Opt	Opt
		MT 5		Opt	Opt

Specifications are subject to change without notice for improvement.

SPECIFICATIONS

Tooling System

unit : mm(in)

L500LMA

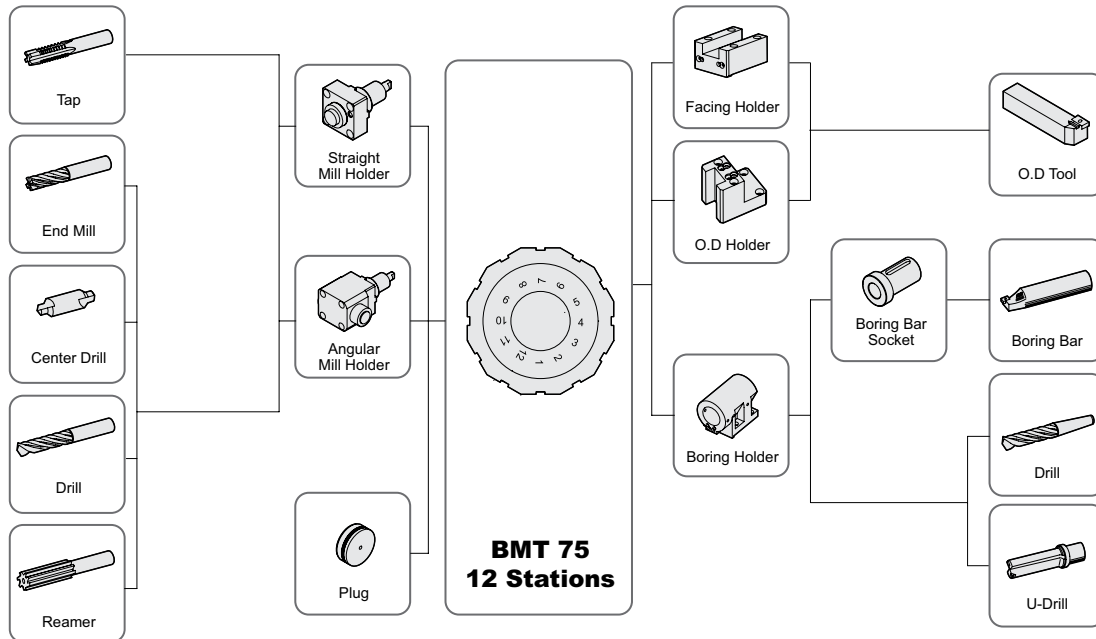

Tooling Parts Detail

ITEM			L500LMA	
			mm Unit	inch Unit
Turning Holder	O.D Holder	Right/Left	2	2
	Facing Holder		2	2
Boring Holder	I.D Holder	Single	4	4
	U-Drill Holder	Tool Holder	Opt	Opt
Driven Holder	Straight Mill Holder	Standard	1	1
	Angular Mill Holder	Standard	1	1
Socket	Boring	Ø20 (Ø3/4")	1	1
		Ø25 (Ø1")	1	1
		Ø32 (Ø1 1/4")	1	1
		Ø40 (Ø1 1/2")	1	1
		Ø50 (Ø2")	1	1
		Ø60	-	-
	Drill	Ø2 1/4"	-	-
		MT 2	-	-
		MT 3	1	1
		MT 4	-	-

SPECIFICATIONS

Interference

unit : mm(in)

L500LA

OD. TOOL HOLDER

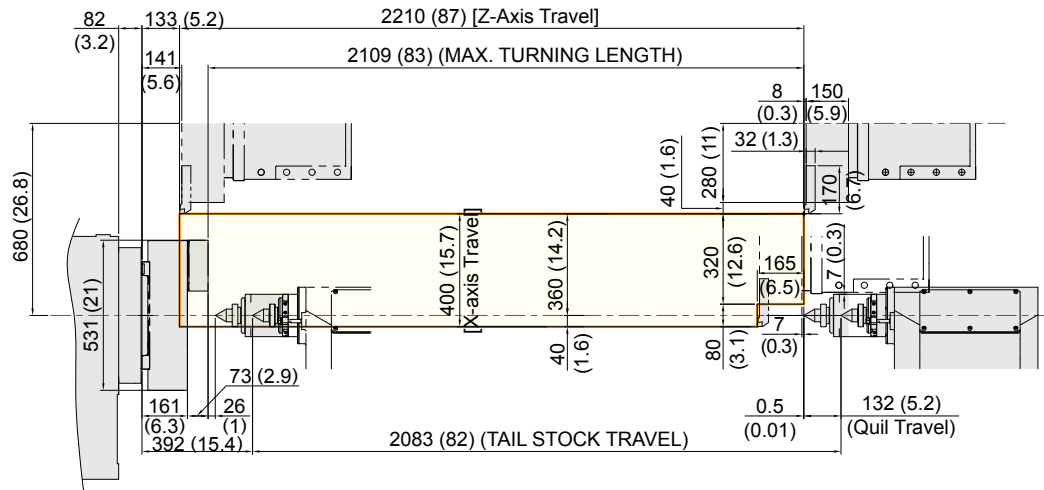

ID. TOOL HOLDER

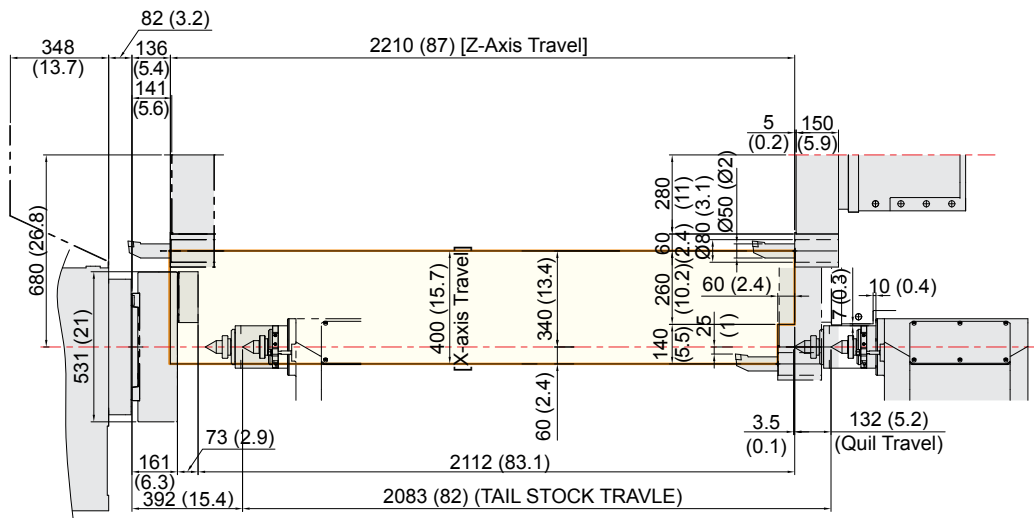

SPECIFICATIONS

Tooling Travel Range

unit : mm(in)

L500LA

EXTENSION OD. TOOL HOLDER

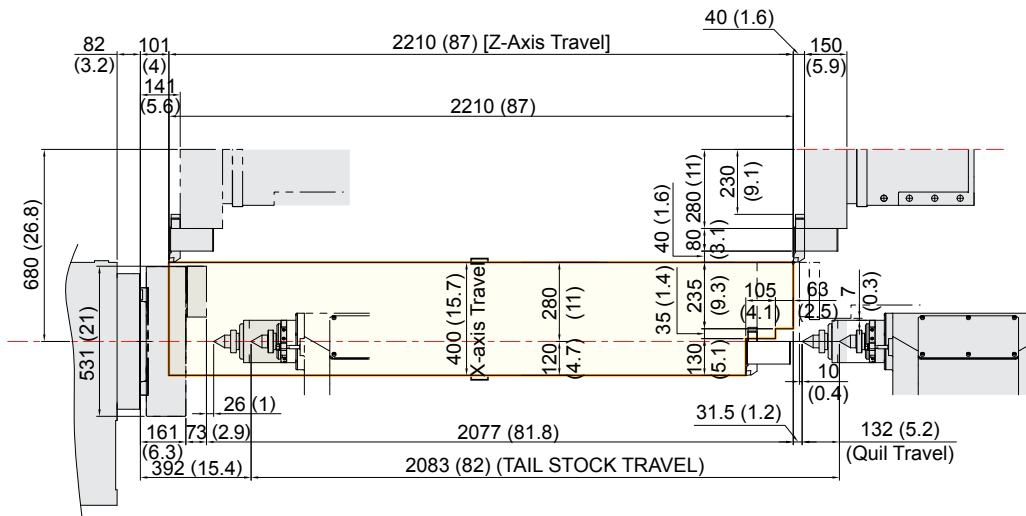

FACE TOOL HOLDER

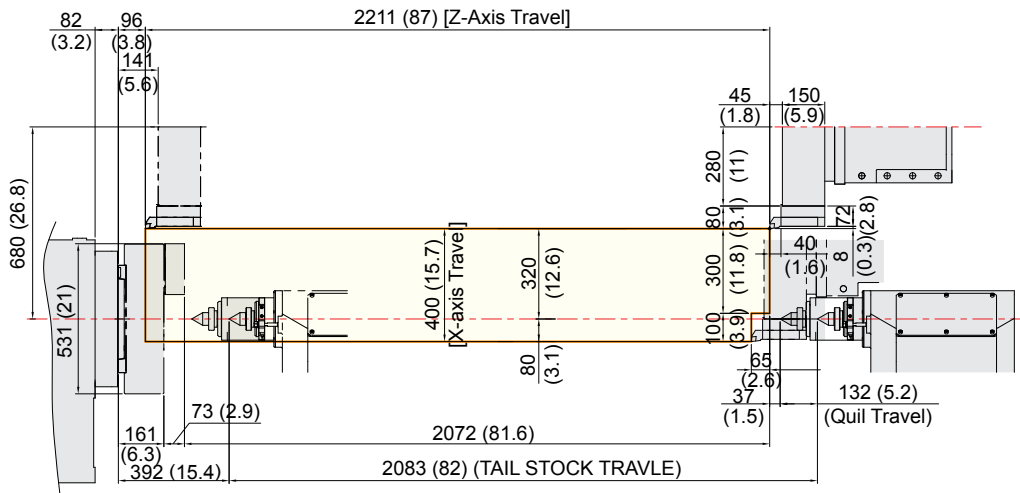

SPECIFICATIONS

Interference

unit : mm(in)

L500LMA

OD. TOOL HOLDER

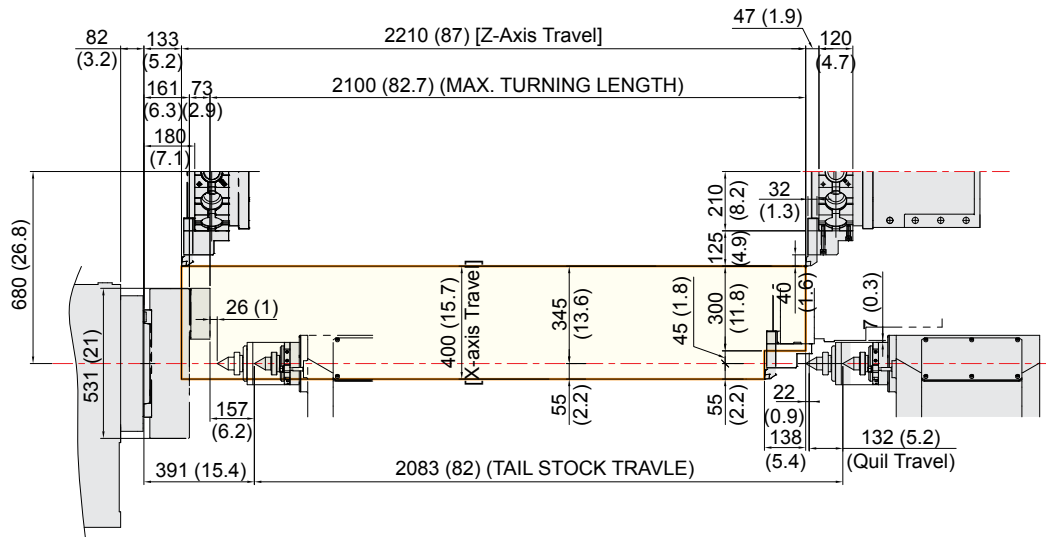

AXIAL DRIVEN HOLDER

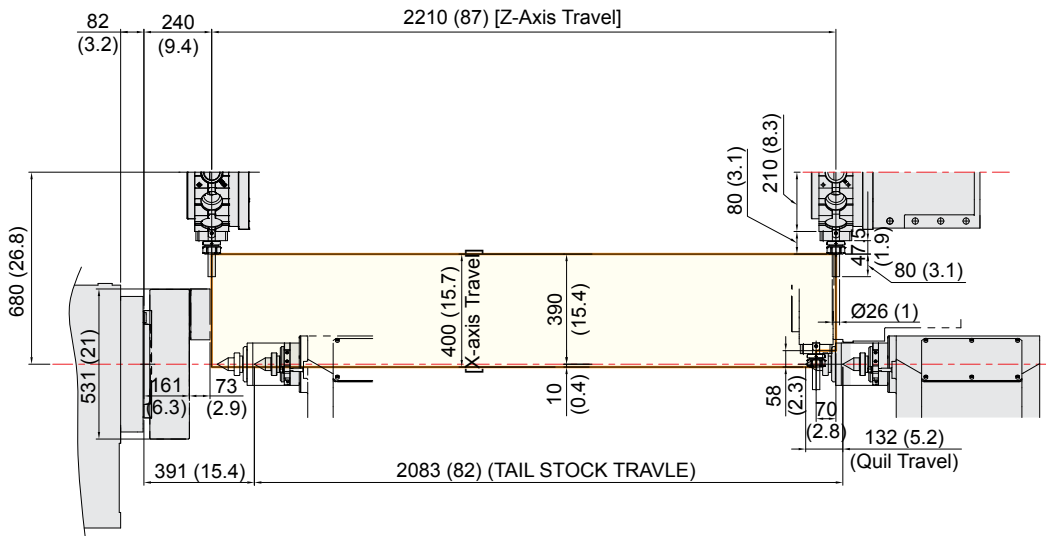

SPECIFICATIONS

Tooling Travel Range

unit : mm(in)

L500LMA

ID. TOOL HOLDER

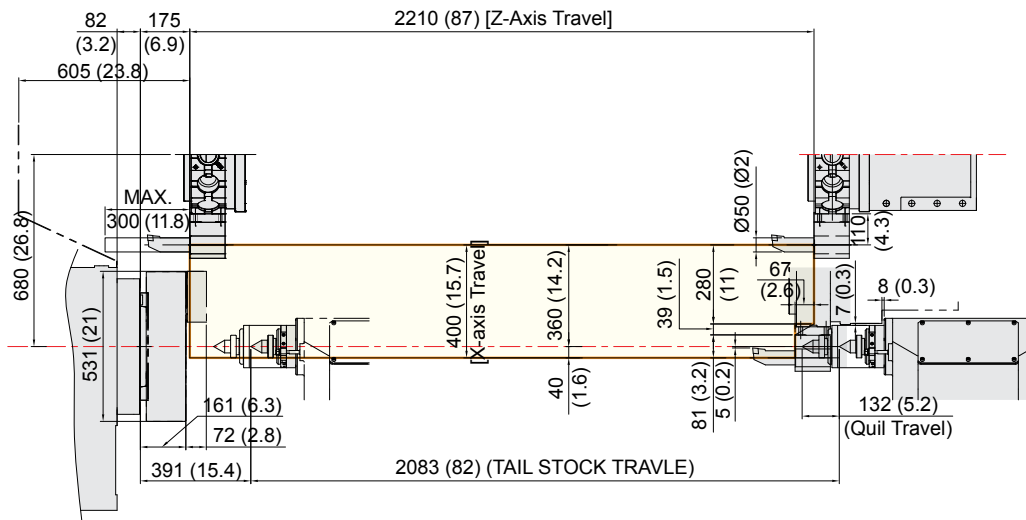

RADIAL DRIVEN HOLDER

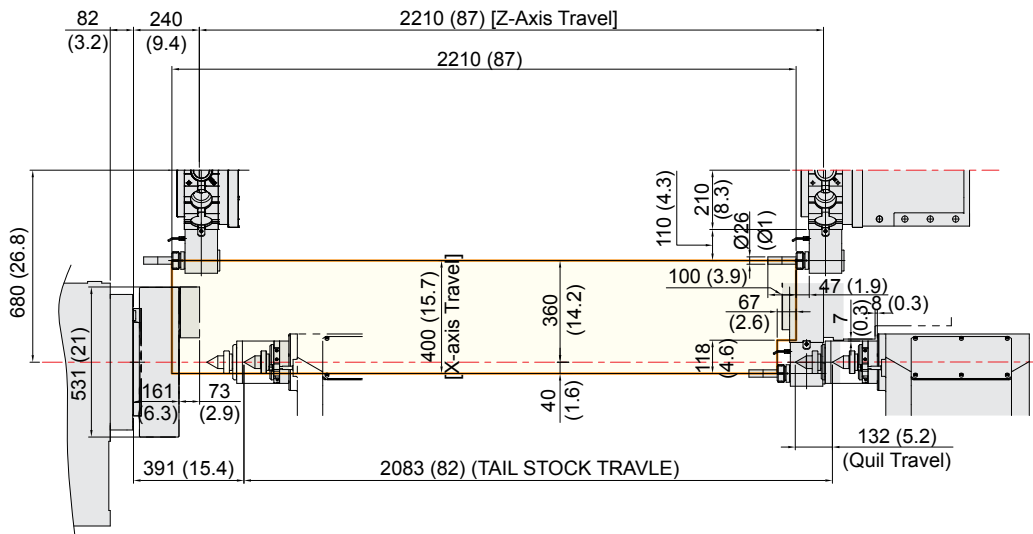

SPECIFICATIONS

Specifications

[] : Option

ITEM			L500LA	L500LMA
CAPACITY	Swing Over the Bed	mm(in)	Ø1,030 (Ø40.6")	
	Swing Over the Carriage	mm(in)	Ø850 (Ø33.5")	
	Max. Turning Dia.	mm(in)	Ø720 (Ø28.3")	Ø690 (Ø27.2")
	Max. Turning Length	mm(in)	2,109 (83")	2,100 (82.7")
	Bar Capacity	mm(in)	Ø165 (Ø6.5")	
SPINDLE	Chuck Size	inch	21" [24"]	
	Spindle Bore	mm(in)	Ø181 (Ø7.1") [Ø275 (Ø10.8")]	
	Spindle Speed (rpm)	r/min	21~1,500 [24~1,000]	
	Motor (Max/Cont.)	kW(HP)	45/37 (60/50)	
	Torque (Max/Cont.)	N·m(lbf·ft)	4,112/3,382 (3,032.9/2,494.4)	2,990/2,459 (2,205.3/1,813.6)
	Spindle Type	-	BELT+2STEP GEAR	
	Spindle Nose	-	A1-15	
	C-axis Indexing	deg	-	0.001°
FEED	Travel (X/Z)	mm(in)	400/2,210 (15.7"/87")	
	Rapid Traverse Rate (X/Z)	m/min	20/18	
	Slide Type	-	BOX GUIDE	
TURRET	No. of Tools	EA	10	12
	Tool Size	OD	□ 32 (□ 1 1/4")	
		ID	Ø80 (Ø3")	Ø63 (Ø2 1/2")
	Indexing Time	sec/step	0.35	
LIVE TOOL	Motor (Max/Cont.)	kW(HP)	-	11/7.5 (15/10)
	Milling Tool Speed (rpm)	r/min	-	4,000
	Torque (Max/Cont.)	N·m(lbf·ft)	-	140/95.4 (103.2/70.4)
	Collet Size	mm(in)	-	Ø26 (Ø1") : ER40
	Type	-	-	BMT75
TAIL STOCK	Taper	-	MT#5 (Built-in)	
	Quill Dia.	mm(in)	Ø150 (Ø5.9")	
	Quill Travel	mm(in)	132 (5.2")	
	Travel	mm(in)	2,083 (82")	
TANK CAPACITY	Coolant Tank	ℓ (gal)	500 (132.1)	
	Lubricating Tank	ℓ (gal)	4 (1.06)	
POWER SUPPLY	Electric Power Supply	kVA	50	
	Thickness of Power Cable	Sq	Over 50	
	Voltage	V/Hz	220/60 (200/50*)	
MACHINE	Floor Space (L×W)	mm(in)	6,420×2,779 (252.8"×109.4")	
	Height	mm(in)	2,420 (95.3")	
	Weight	kg(lb)	15,200 (33,510)	
PC	Controller	-	FANUC 32i-B	

* Prior consultation is required when applying spindle contouring control for gear driven spindle.

*) Using 50Hz voltage instead of 60Hz may lower the output of motors. (excluding servo motors and inverter motors)
Specifications are subject to change without notice for improvement.

CONTROLLER

FANUC 32i-B

[] : Option

Controlled axis / Display / Accuracy Compensation	
Control axes	2 axes (X, Z) / 3 axes (X, Z, C) / 4 axes (X, Z, Y, C) 5 axes (X, Z, B, C, A) / 6 axes (X, Z, Y, B, C, A)
Simultaneously controlled axes	2 axes [Max. 4 axes]
Designation of spindle axes	4 axes (1 path), 6 axes (2 path Total)
Least setting Unit	X, Z, Y, B axes : 0.001 mm (0.0001 inch) C, A axes : 0.001 deg
Least input increment	X, Z, Y, B axes : 0.001 mm (0.0001 inch) C, A axes : 0.001 deg
Inch / Metric conversion	G20 / G21
High response vector control	
Interlock	All axes / Each axis
Machine lock	All axes
Backlash compensation	± 0 ~ 9999 pulses (Rapid traverse / Cutting feed)
Position switch	
LCD / MDI	10.4 inch color LCD
Feedback	Absolute motor feedback
Stored stroke check 1	Over travel
Stored stroke check 2, 3	
PMC axis control	
Operation	
Automatic operation (Memory)	
MDI operation	
DNC operation	Needed DNC software / CF card
Program restart	
Wrong operation prevention	
Program check function	Dry run, Program check
Single block	
Search function	Program Number / Sequence Number
Interpolation functions	
Nano interpolation	
Positioning	G00
Linear interpolation	G01
Circular interpolation	G02, G03
Exact stop mode	Single : G09, Continuous : G61
Dwell	G04, 0 ~ 9999.9999 sec
Skip	G31
Reference position return	1st reference : G28 2nd reference : G30 Ref. position check : G27
Thread synchronous cutting	
Thread cutting retract	
Variable lead thread cutting	
Multi / Continuous threading	
Feed function / Acc. & Dec. control	
Manual feed	Rapid traverse Jog : 0~2,000 mm/min (79 ipm) Manual handle : x1, x10, x100 pulses Reference position return
Cutting Feed command	Direct input F code
Feedrate override	0 ~ 200% (10% Unit)
Rapid traverse override	F1%, F25%, 50%, F100%
Override cancel	
Feed per minute	G98
Feed per revolution	G99
Look-ahead block	1 block
Program input	
Tape Code	EIA / ISO
Optional block skip	1 ea
Absolute / Incremental program	G90 / G91
Program stop / end	M00, M01 / M02, M30
Maximum command unit	± 999,999.999 mm (± 99,999.9999 inch)
Plane selection	X-Y : G17 / Z-X : G18 / Y-Z : G19
Workpiece coordinate system	G52, G53, 6 pairs (G54 ~ G59)
Manual absolute	Fixed ON
Programmable data input	G10
Sub program call	10 folds nested
Custom macro	#100 ~ #149, #500 ~ #549
G code system	A
Programmable mirror image	G51.1, G50.1
G code preventing buffering	G41
Multiple repetitive cycles I, II	

Program input	
Canned cycle for turning	
Manual Guide i	Conversational auto program
Auxiliary function / Spindle speed function	
Auxiliary function	M 4 digit
Level-up M Code	High speed / Multi / Bypass M code
Spindle speed function	S 4 digit, Binary output
Spindle override	0% ~ 150% (10% Unit)
Multi position spindle orientation	M19
Rigid tapping	
Constant surface speed control	G96, G97
Tool function / Tool compensation	
Tool function	T 2 digit + Offset 2 digit
Tool life management	
Tool offset pairs	32 pairs
Tool nose radius compensation	G40, G41, G42
Geometry / Wear compensation	
Direct input of offset measured B	
Editing function	
Part program storage size	640m (256KB)
No. of registerable programs	500 ea
Program protect	
Background editing	
Extended part program editing	Copy, move and change of NC program
Memory card program edit	
Data input / output & Interface	
I/O interface	RS 232C serial port, CF card, USB memory Embedded Ethernet interface
Screen hard copy	
External message	
External key input	
External workpiece number search	
Automatic data backup	
Setting, display and diagnosis	
Self-diagnosis function	
History display & Operation	Alarm & Operator message & Operation
Run hour / Parts count display	
Maintenance information	
Actual cutting feedrate display	
Display of spindle speed / T code	
Graphic display	
Operating monitor screen	Spindle / Servo load etc.
Power consumption monitoring	Spindle & Servo
Spindle / Servo setting screen	
Multi language display	Support 20 languages
Display language switching	Selection of 5 optional Languages
LCD Screen Saver	Screen saver
Unexpected disturbance torque	BST (Back spin torque limit)
Function for machine type	
Cs contour control (C & A axes)	Mill, MS, Y, SY, LF-Mill, TTMS, TTSY
Polar coordinate interpolation	Mill, MS, Y, SY, LF-Mill, TTMS, TTSY
Cylindrical interpolation	Mill, MS, Y, SY, LF-Mill, TTMS, TTSY
Canned cycle for drilling	Mill, MS, Y, SY, LF-Mill, TTMS, TTSY
Spindle orientation expansion	MS, SY TTS, TTMS, TTSY
Spindle synchronous control	MS, SY TTS, TTMS, TTSY
Torque control	MS, SY TTS, TTMS, TTSY
Y axis offset	Y, SY, TTSY
Arbitrary angular control	Y, SY, TTSY
Composite / Superimposed control	MS, SY TTS, TTMS, TTSY
Balance cutting	MS, SY TTS, TTMS, TTSY
Option	
Additional optional block skip	9 ea
Fast ethernet	Needed option board
Data server	Needed option board
Protection of data at 8 levels	
Tool offset pairs	64 pairs / 99 pairs / 200 pairs
Part program storage size	1280 m (512KB) / 2560m (1MB)
Polygon turning (2 Spindles)	Mill, MS, Y, SY, LF-Mill, TTMS, TTSY
Helical interpolation	
Dynamic graphic display	
Direct drawing dimension program	Including Chamfering / Corner R

Figures in inch are converted from metric values.

The FANUC controller specifications are subject to change based on the policy of company CNC supplying.

HW-MMS

HYUNDAI WIA Machine Monitoring System



A brand new manufacturing machine by Hyundai Wia, HW-MMS is a unique software capable of monitoring the operation status of manufacturing machines in factories, a smart solution to improve manufacturing conditions of customers.

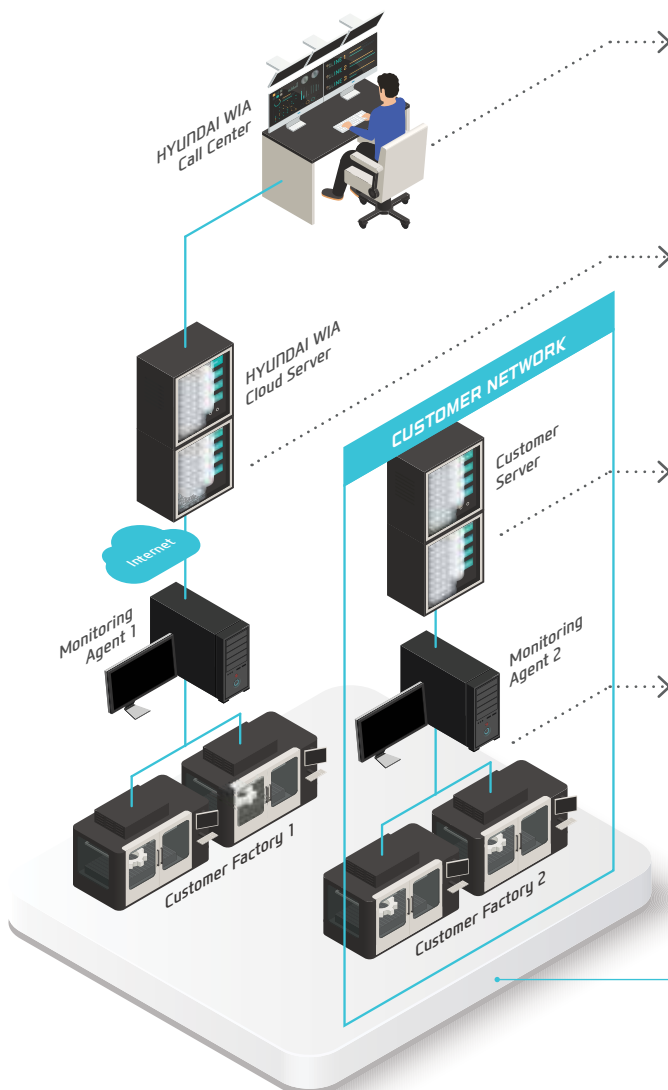

HW-MMS Remote

Hyundai Wia Call Center's remote diagnosis service provides a HMI/video diagnostic function.



HW-MMS Cloud

A cloud server-based equipment monitoring system for collecting and analyzing facility operation data.



HW-MMS Edge

A client server-based tool monitoring system for collection/analysis of facility operation data. (Compatible with client MES / ERP interface)



HW-MMS PT

This is a facility big data-based smart factory solution that collects and analyzes changes in spindle/feed data and NC processing files

HYUNDAI WIA
Smart Factory Solution



L500LMA
Movie 1



L500LMA
Movie 2



L500LMA
3D Movie



You Tube HYUNDAI WIA MT

www.youtube.com/HYUNDAIWIAMT

EXPERIENCE THE NEW TECHNOLOGY

With its top-quality HYUNDAI WIA machine tool creates a new and better world.



<http://machine.hyundai-wia.com>

HYUNDAI WIA Machine Tools
Global Links

HEADQUARTER

Changwon Technical Center/R&D Center/Factory 153, Jeongdong-ro, Seongsan-gu, Changwon-si, Gyeongsangnam-do, Korea TEL : +82 55 280 9114 FAX : +82 55 282 9114

Overseas Sales Team /R&D Center 37, Cheoldobangmulgwan-ro, Uiwang-si, Gyeonggi-do, Korea TEL : +82 31 8090 2539

OVERSEAS OFFICES

HYUNDAI WIA Machine America corp. 450 Commerce Blvd, Carlstadt, NJ 07072, USA TEL : +1-201-987-7298

HYUNDAI WIA Europe GmbH Alexander-Fleming-Ring 57, 65428 Rüsselsheim Germany TEL : +49-0-6142-9256-0

HYUNDAI WIA Machine Tools China 2-3F, Bldg6, No.1535 Hongmei Road, Xuhui District, Shanghai, China TEL : +86-21-6427-9885

India Branch Office #4/169, 1st Floor, LOTTE BLDG, Rajiv Gandhi Salai, (OMR), Kandanchavadi, Chennai - 600096, Tamilnadu, India TEL : +91-76-0490-3348

Vietnam Branch Office Flat number 05, Service and Trade Center of Viet Huong Industrial Zone, Highway 13, Thuan Giao, Thuan An, Binh Duong, Vietnam TEL : +84-3-5399-5099