







## 1200x1400 HERKULES X

 mm	 mm	 a b a x b	 a b a x b
1200	1200	1200x1400	1200x680

				
3x400 V	11,0	15-80	11650x80x1,6	25000
L	B	Hmin	Hmax	V
5200	2700	2850	4100	760

\* doporučená hodnota. Při překročení doporučeného maximálního průměru není možné garantovat výkon pilového pásu!  
/recommended value. The blade performance cannot be guaranteed when the recommended diameter is exceeded!

 a x b - řezání svazků bez horního přitlaku / cutting of the bundle without top clamping/

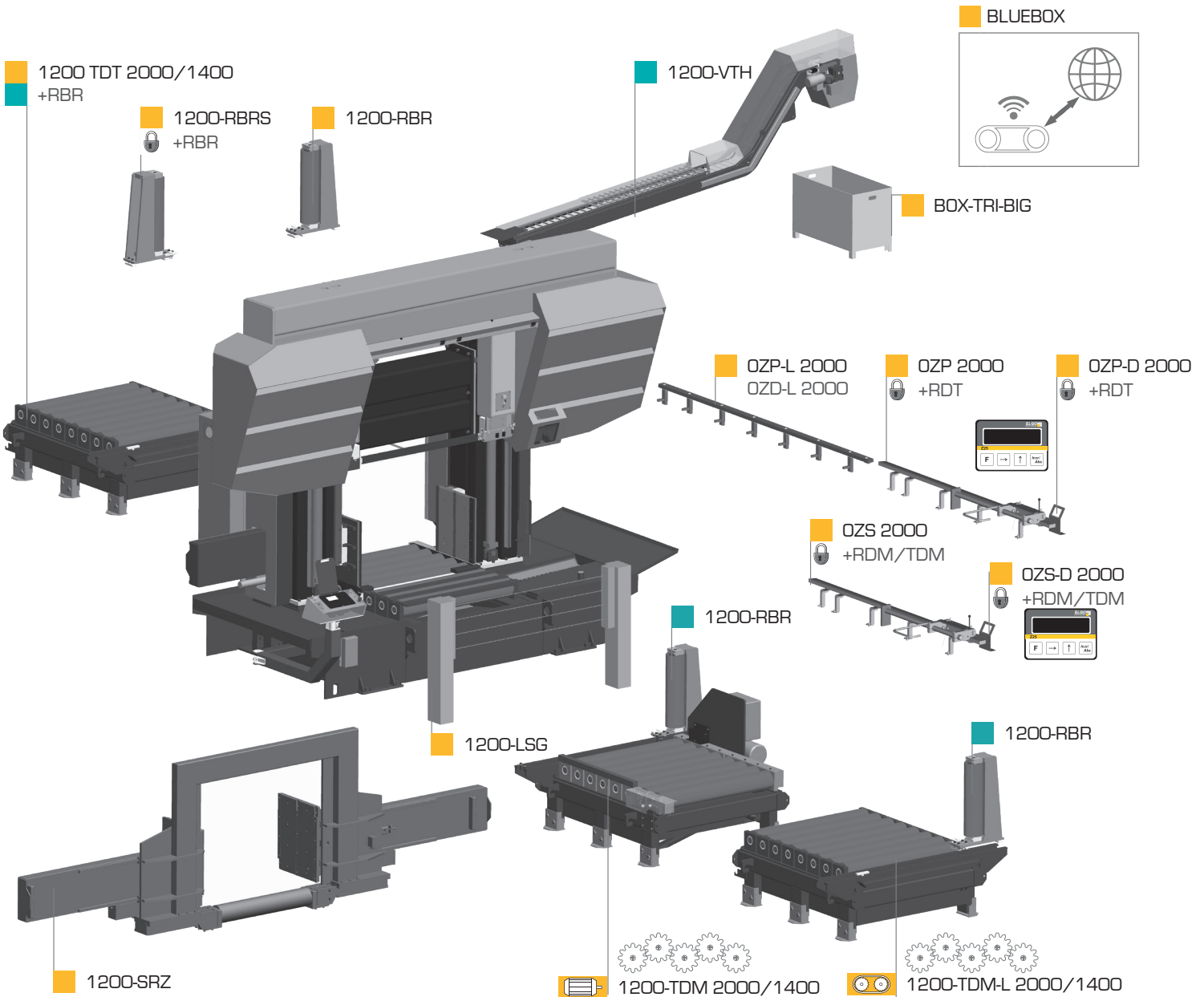
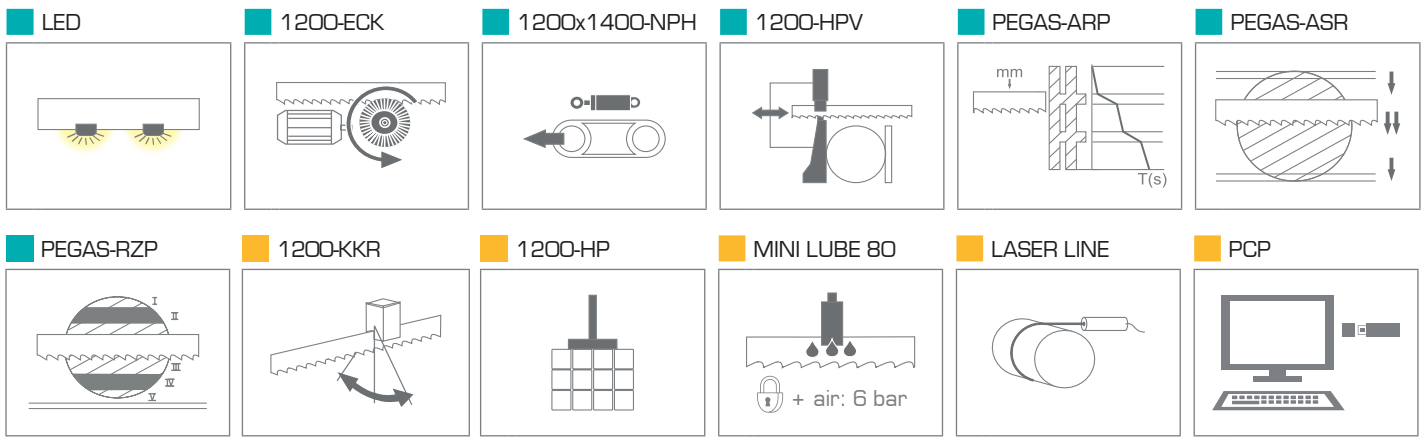

# 1200x1400 HERKULES X

■ STANDARD ■ OPTION



**PEGAS-GONDA s.r.o.**, Čs.armády 322, 684 01 Slavkov u Brna, CZECH REPUBLIC  
Tel: 00420-544 221 125 (126), Fax: 00420-544 227 389, E-mail: pegas@gonda.cz  
[www.pegas-gonda.cz](http://www.pegas-gonda.cz)

- výrobce si vyhrazuje právo provádět změny technických údajů, technické údaje odpovídají 1.3.2018  
/ producer has the right to make changes of technical data, technical data are valid on 1.3.2018 /  
- pila na fotografii není vždy v základním provedení, uvedené rozměry odpovídají stroji v základním provedení  
/ the machine in the picture is not always in the basic version, mentioned diameters are for machine in basic version /

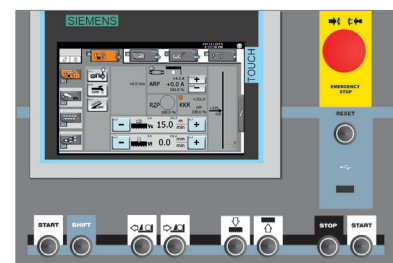

CONTROL PANEL:SIEMENS (X)