











250x315 GH-LR

250x315 SH-LR

	$\square 0^\circ$	$\square 45^\circ$	$\square 60^\circ$	$\square 45^\circ$	$\square 60^\circ$	$\begin{matrix} b \\ a \times b \end{matrix}$
	250	190	120	170	x	x
	150*	110*	80*	110*	x	x
	290x200	190x140	120x140	200x70	x	200x120

				
3x400V	0,75/1,1	37/74	2825x27x0,9	GH: 380
Lmin	B	Hmin	Hmax	V
1550	750	1420	1870	970
				SHI: 420

* doporučená hodnota. Při překročení doporučeného maximálního průměru není možné garantovat výkon pilového pásu!
/recommended value. The blade performance cannot be guaranteed when the recommended diameter is exceeded!

 $\begin{matrix} b \\ a \times b \end{matrix}$ - řezání svazků bez horního přtlaku / cutting of the bundle without top clamping/

250-M2V

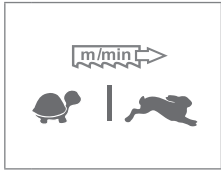

240-CK

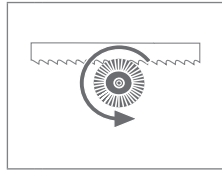

250-HP (SH)

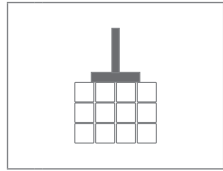

R 290

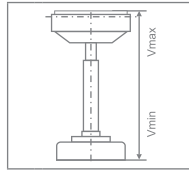

	S (mm)	Vmin (mm)	Vmax (mm)
R	290	760	980

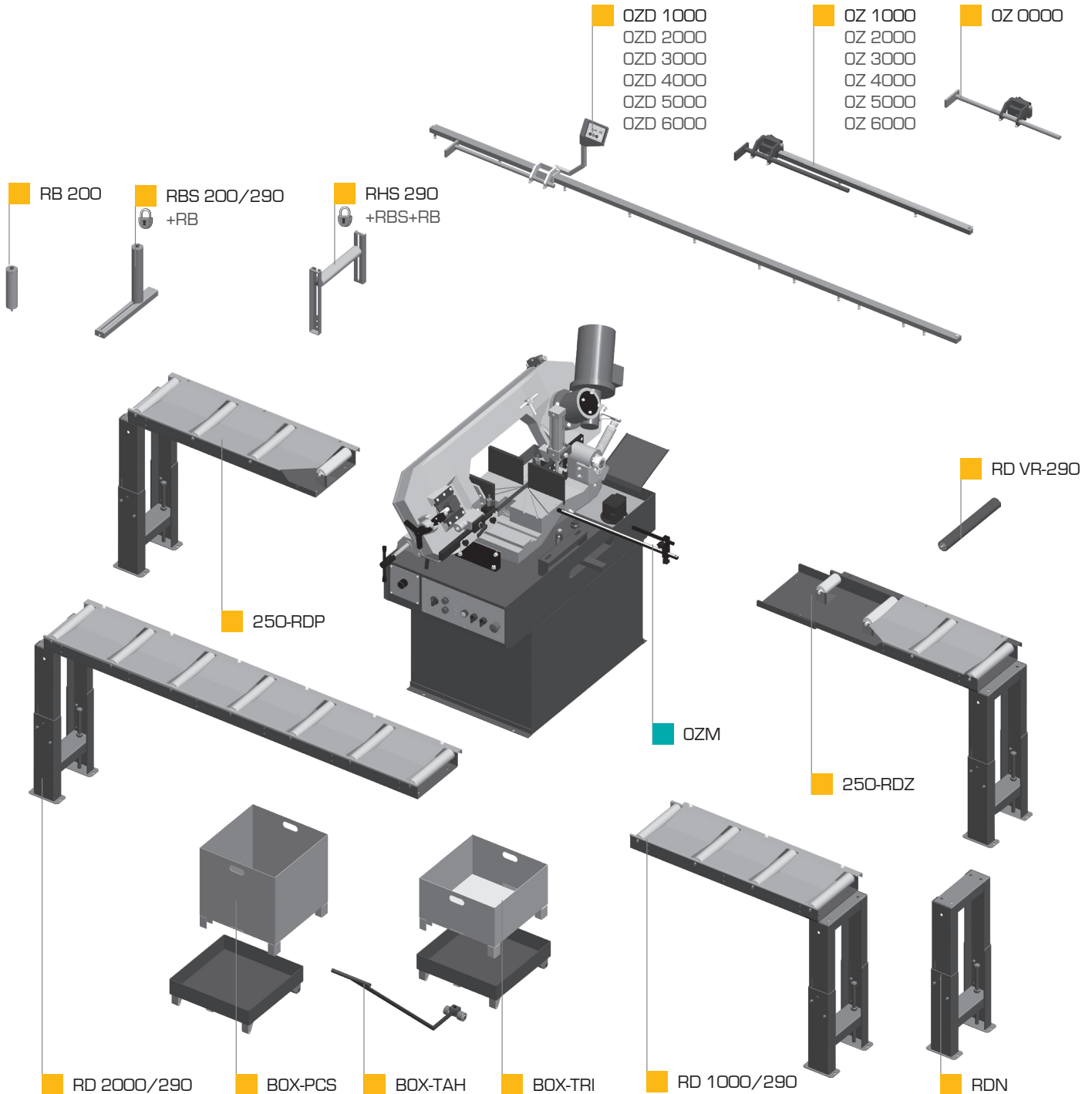

250x315 GH-LR, 250x315 SH-LR

■ STANDARD

■ OPTION



PEGAS-GONDA s.r.o., Čs.armády 322, 684 01 Slavkov u Brna, CZECH REPUBLIC
 Tel: 00420-544 221 125 (126), Fax: 00420-544 227 389, E-mail: pegas@gonda.cz
 www.pegas-gonda.cz

- výrobce si vyhrazuje právo provádět změny technických údajů, technické údaje odpovídají 1.3.2018
 / producer has the right to make changes of technical data, technical data are valid on 1.3.2018 /
 - píla na fotografii není vždy v základním provedení, uvedené rozměry odpovídají stroji v základním provedení
 / the machine in the picture is not always in the basic version, mentioned diameters are for machine in basic version /

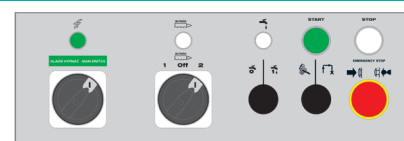

CONTROL PANEL:GH



CONTROL PANEL:A2