



# TUR SMN 800/930/1100

POWER...PRECISION...PERFORMANCE!



for impressive  
performances



## TUR SMN 800/930/1100

Exceptional stability with high precision and unrivalled quality, FAT lathes will provide many years of reliable service for your business. The best combination of price and high efficiency – your most cost effective solution. We are confident there is no better choice for your work shop on the market today!

TUR SMN 800/930/1100 is a high precision, high quality European product 100% manufactured in Poland. The purchased parts used in all our products only come from world leaders in machine tools parts manufacture and supply.

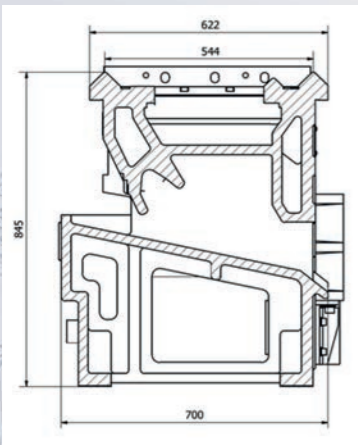
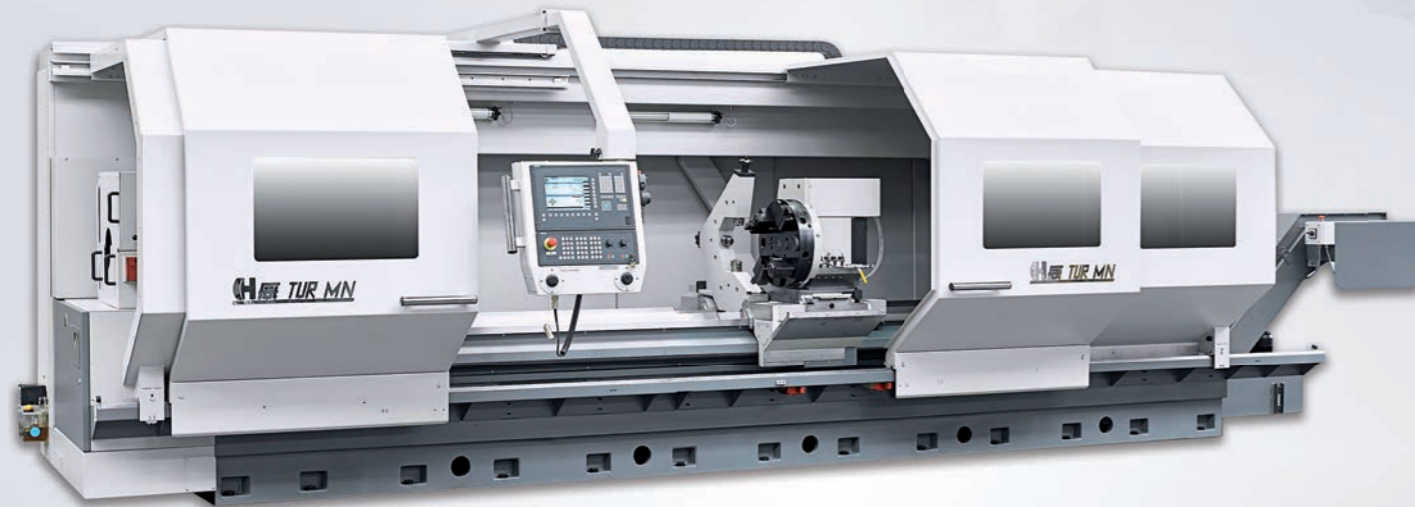

Special, mono-block type bed made of cast iron is a rigid structure which perfectly absorbs vibrations. Extra wide, deeply hardened and ground guide ways 3-V ensure precise machining and excellent surface quality. All of the above guarantee long-life accurate operation of the lathe.

The headstock is made of one mono-block casting. Hand scraped contact surfaces ensure the best fit and durable alignment. High precision spindle bearings guarantee excellent stability and accuracy of machining.

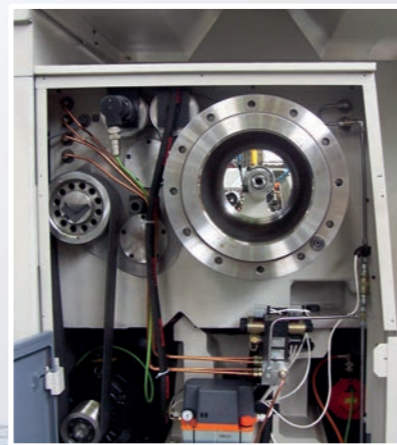

Easy access to the working area.  
Surprisingly small distance to spindle axis



The standard tailstock has 125mm quill diameter. For heavy duty machining the diameter can be increased up to 140mm or 160mm. The quill is located in a specially extended body. Optionally the tailstock can be equipped with hydraulic quill, bearing system for the dead center, independent NC drive and hydraulic clamping system to the bed.

## TUR 4SMN 930/1100

The design of machine is based on proven, high quality TUR SMN. The wide step bed ensures great stability and geometrical accuracy. Step bed allows machining workpiece without collision between saddle and steady rests.

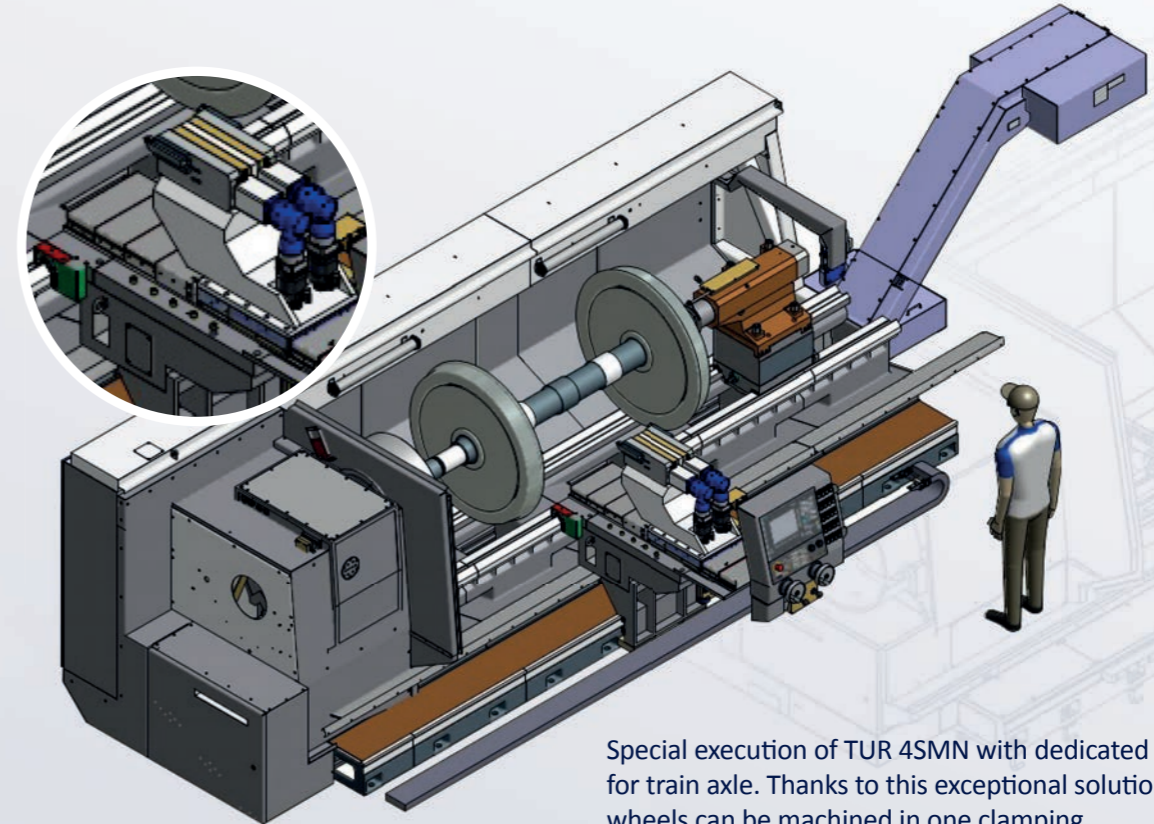

Special execution of TUR 4SMN with dedicated tooling system for train axle. Thanks to this exceptional solution both shaft and wheels can be machined in one clamping.

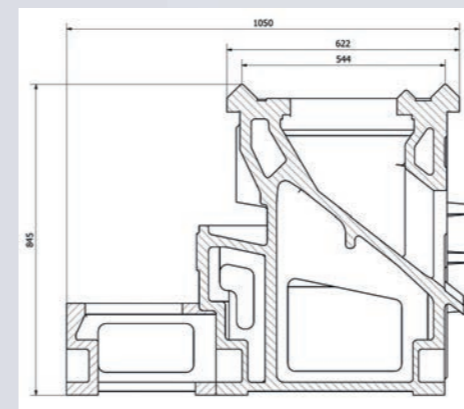

The enormous wide 1-piece mono-bloc bed with 3-V prismatic guide ways is made from high-grade cast iron. The biggest advantage of TUR 4SMN is bed's design. It has 4 guide ways: 2 outer for carriage and other 2 outer for steady rests. Thanks to this execution the tooling system drives over steady rests without collision.

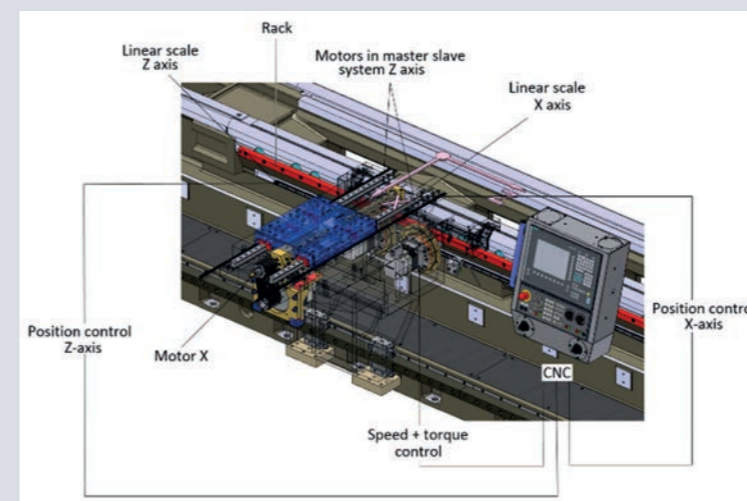

Longitudinal travel is performed by means of rack and pinion mechanism. Automatic backlash compensation ensures Master&slave system.



TUR 4SMN 930 x 10 000 with hydraulic self-centering steady rests. Automatic approach to the working position allows machining of bigger diameters.

# OPTIONAL EQUIPMENT:

## Tailstock executions:

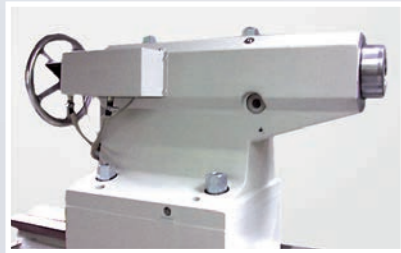

Quill operated both manually and hydraulically

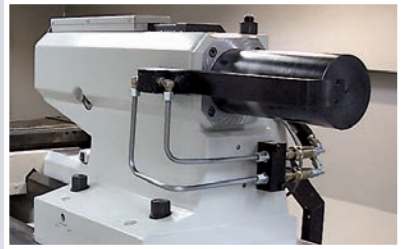

Hydraulic tailstock quill



Heavy-duty tailstock with 160 mm quill diameter for increased rigidity and load capacity

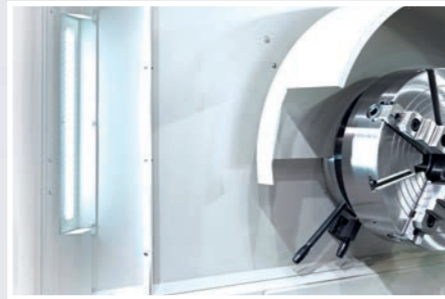

LED light front



Oil mist collector

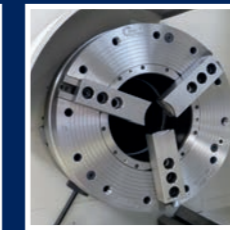
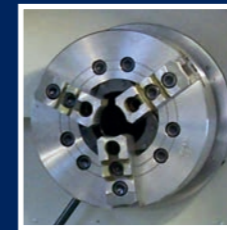

Wide variety of manual, hydraulic and pneumatic chucks

A wide range of rests is available to suit different machining applications: manual, hydraulic self-centring, steady or follow rests, C-form, ring rests and other.

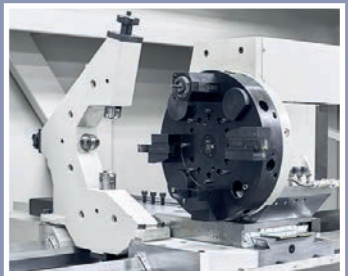

Full enclosure

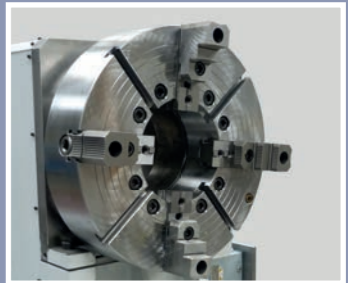
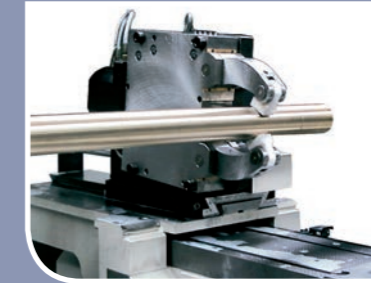
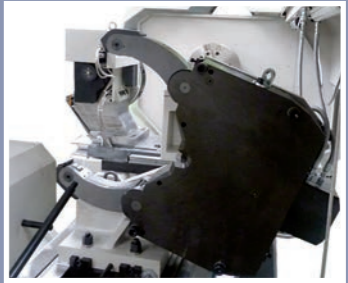
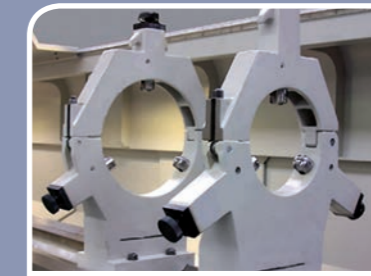

## Tooling system:



Parat toolpost with optional Capto seat



Disc turret for static tools



Combination of two 4-positions Sauter head-type turrets



Sauter head-turret with milling unit on the rear T-slots



Sauter or Baruffaldi turret for driven tools with C axis



## Spindle equipment:

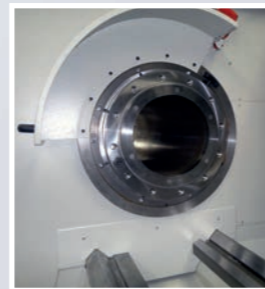

Available spindle  $\varnothing$ 140mm (standard), 220mm,  $\varnothing$ 320mm,  $\varnothing$ 360mm, 450mm



Second spindle nose

## C axis:

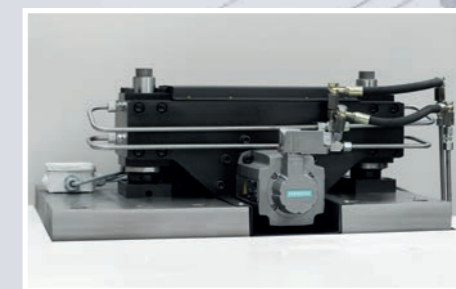

Full contouring C axis with independent, direct drive on the spindle enables precise milling operations with interpolating work piece.

## Milling-drilling units:



Standard Multifix D1 toolpost

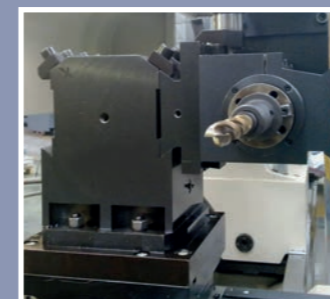

Tooling system mounted on cross-slide T slots



Unit mounted on tool turret



WTO system (VDI50) enables drilling and milling operations with a high torque. Normal turning is still possible. Available version with Y-axis and Capto seat.

## MACHINE STANDARD EQUIPMENT

- CNC Siemens 840D SL
- Toolpost type Multifix Size D1
- Tube lights (24V) in working area
- Complete coolant system
- Hydraulic aggregate
- Independent Z position operator panel
- Come-along system – quick coupling between tailstock and carriage
- Emergency switch between tailstock and carriage
- Full rear guarding with sliding access doors
- Hand wheels for manual operation
- Automatic lubrication system
- Automatic gear change
- USB Port
- Absolute encoders



Heavy-duty boring bar attachment mounted on rear T-slots.

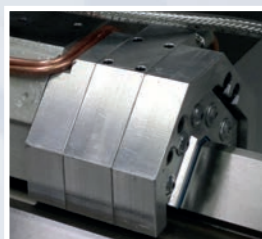

Scrapers with compressed air for guideways

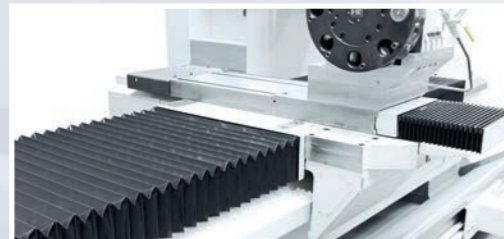

Bellows cover



Additional coolant tank with filtration and high pressure pump

## Surprisingly easy programming!

TUR SMN with Siemens 840D SL allows you to work manually, semi-automatic or full CNC. The user friendly Siemens Shop Turn Conversational Programming System will make your work efficient and enjoyable.

### Essential features:

- easy programming using graphics and without need for knowledge of DIN/ISO
- extremely short programming time
- clear display of all technical in machining sequence
- prevention of invalid inputs thanks dynamic online graphics
- simply management of tools
- wide range of standard machining and measuring cycles



Large 15" touchscreen



Fanuc or Fagor controller as an option

## TECHNICAL PARAMETERS

		TUR 800 SMN	TUR 930 SMN TUR 930 4SMN	TUR 1100 SMN TUR 1100 4SMN		
<b>CAPACITY</b>						
Distance between centres (other lengths on special request)	mm	2.000 – 3.000 – 4.000 – 5.000 – 6.000 – 8.000 ... 16.000				
Swing over bed	mm	800	950	1.100		
Swing over saddle	mm	500	630	790		
Max. weight between centres (option)	kg	4.000 (7.000)	4.000 (7.000)	4.000 (7.000)		
Max. weight in chuck only	kg	1.000	1.000	1.000		
<b>HEADSTOCK</b>						
Spindle speed range	rpm	4 - 1.800	4 - 1.200			
Main drive motor power (S6)	kW	33	33	33		
Turning torque	Nm	4.100	4.900	4.900		
Spindle bore	mm	140	140	140		
<b>Optional execution</b>						
Spindle bore	mm	165	220	320	360	450
<b>SADDLE</b>						
Cross slide travel X-axis	mm	505	570	610		
Rapid travel Z-axis	m/min	6	6	6		
Rapid travel X-axis	m/min	6	6	6		
<b>TAILSTOCK</b>						
Quill diameter	mm	125 (140/160 option)	125 (140/160 option)	125 (140/160 option)		
Quill taper	size	MT 6 (MT5 for option with bearing system)				
Quill stroke	mm	300	300	300		
<b>GENERAL</b>						
Width of bed	mm	622	622	622		
Total length of machine						
2.000 / 3.000 / 4.000 / 5.000 / 6.000 / ... / 16.000 mm b.c.	mm	4.400 / 5.400 / 6.400 / 7.400 / 8.400 / ... / 18.400				
Width of machine	mm	3.050	3.050	3.050		
Height of machine	mm	2.000	2.100	2.250		
Weight of machine (approx.)						
2.000 mm b.c.	kg	11.200	11.700	12.200		
3.000 mm b.c.	kg	12.300	12.800	13.300		
4.000 mm b.c.	kg	13.500	14.000	14.500		
5.000 mm b.c.	kg	14.800	15.300	15.800		
6.000 mm b.c.	kg	16.200	16.700	17.200		
16.000 mm b.c.	kg	27.200	27.700	28.200		

FAT Haco offers you the benefit of our vast experience – since the year 1945 over 50.000 machine tools have been sold in many countries around the world!

Our excellently equipped machine shop, assembly facility, research office and our own foundry allows us to manufacture most components by ourselves - complete from casting to the finished product. FAT works closely with you to develop the absolute best product for your needs. Our experience and quick reaction time will save you both time and money.

Together, let's make creative imagination our only limitation!

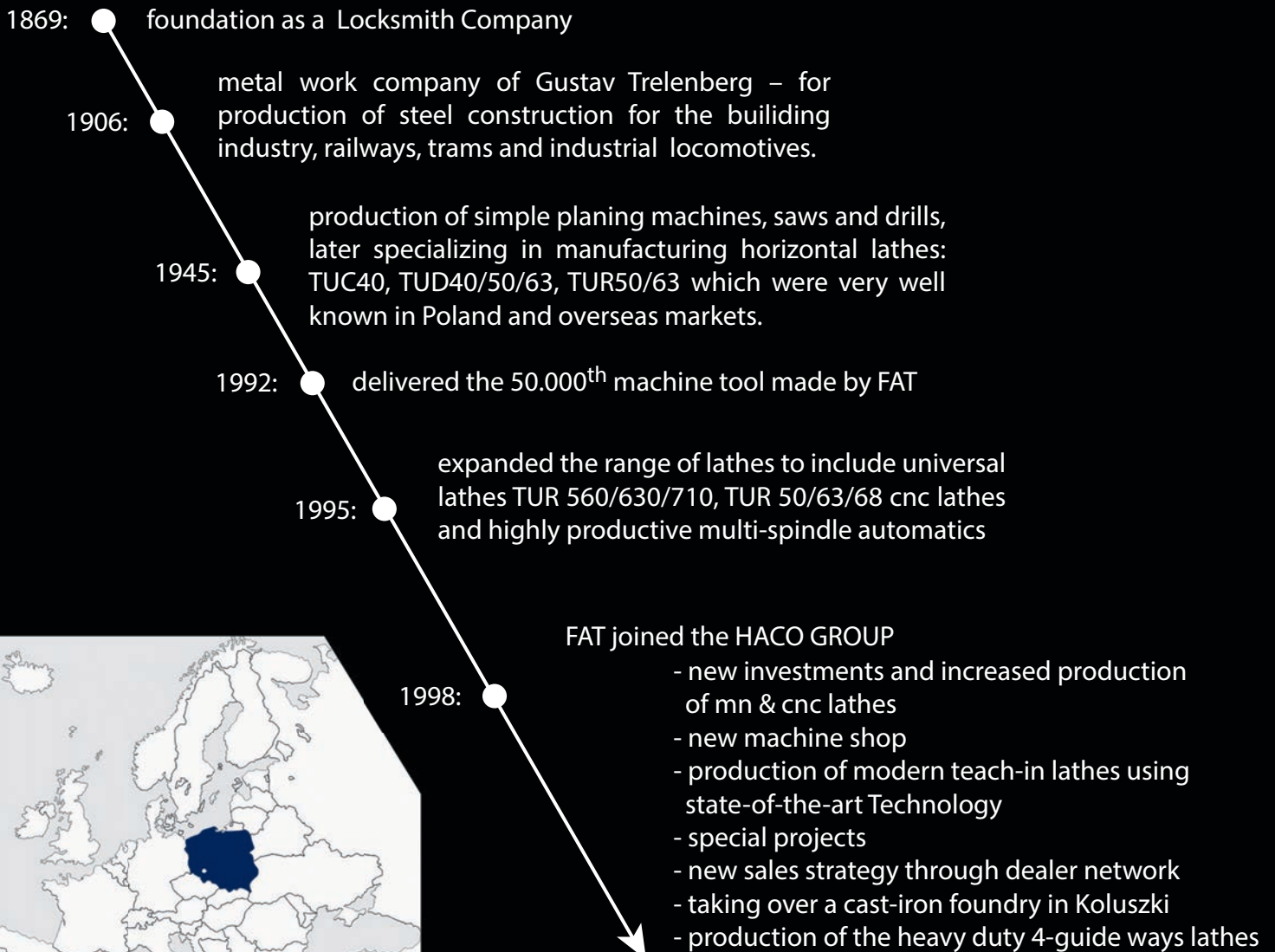

for impressive performances

Fabryka Automatów Tokarskich S. A.  
Grabizyńska Street 281  
PL 53-234 Wrocław POLAND  
GPS: N 51.09567, E. 16.97921

Office:  
Phone: +48 71 36 09 100  
Fax: +48 71 36 09 121

info@fathaco.com www.fathaco.com

Representative:

