

# 600/700/800 Series

L600 Series | L700 Series | L800 Series | L800D Series

HYUNDAI WIA Heavy Duty CNC Turning Center

# Technical Leader

The CNC Turning Center L600,700,800 Series designed by Hyundai WIA with years of expertise and the latest technology, is a Turning Center that maximizes productivity and performance.

ITEM	Chuck					Bed		Turret	
	18"	21"	24"	32"	34"	Standard	Long	Std. Turret	Mill Turret
L600A	○	○				●		●	
L600LA	○	○					●	●	
L600MA	○	○				●			●
L600LMA	○	○					●		●
L700A			○			●		●	
L700LA			○				●	●	
L700MA			○			●			●
L700LMA			○				●		●
L800A				○		●		●	
L800LA				○			●	●	
L800MA				○		●			●
L800LMA				○			●		●
L800D				○	○	●		●	
L800LD				○	○		●	●	
L800MD				○	○	●			●
L800LMD				○	○		●		●

●: Standard ○: Option



# 600/700/800 Series

Heavy-Duty Cutting, Large Work Capacity, CNC Turning Center

- Sturdiness secured through box guideways on all axes
- One piece structure for high accuracy and rigidity
- Pretensioned double anchored method provides high precision
- Gear box type main spindle (L600/700 Series : 3 step / L800 Series : 2 step)
- Big Bore Spindle with a maximum spindle bore of  $\varnothing 375$  ( $\varnothing 14.8$ " ) (L800D Series)
- Structure designed for machining long shafts and pipes with maximum turning length of 3,250mm (128") (Long Bed Type)



# 01 BASIC STRUCTURE

High Rigid Bed & Structure for Heavy Duty Cutting CNC Turning Center



## BMT85 Mill Turret

- 3,000 rpm
- Collet Size :  $\varnothing 34$  (1.3")/ER50

## Servo Turret

- No. of Tools : 12 EA
- Tool Size (O.D/I.D)  
□ 32/ $\varnothing 80$  ( $\varnothing 1 \frac{1}{4}$ "/ $\varnothing 3$ " )

## High Precision Spindle

- L600 Series : 1,800 r/min
- L700 Series : 1,500 r/min
- L800 Series : 700 r/min
- L800D Series : 500 r/min
- C-Axis Control : 0.001° ('M' Type)
- Big Bore Spindle (L800/D Series)

L800D

L700LMA

## Spindle Gear Box

- L600/700 Series : 3 Step
- L800 Series : 2 Step

## Built-in Tail Stock

- Taper : MT#6
- Quill Travel : 132.5 mm (5.2")

# POWERFUL CUTTING CAPABILITY & WIDE CUTTING AREA

## ALL-IN-ONE TYPE OF BED

### High Precision & Rigidity, One-Piece Structure

The L600/700/800 series features a 45° slant bed design which is developed through finite element analysis (FEA) to effectively absorb vibration and minimize heat generation. The structure ensures stability which enables powerful and precise cutting.

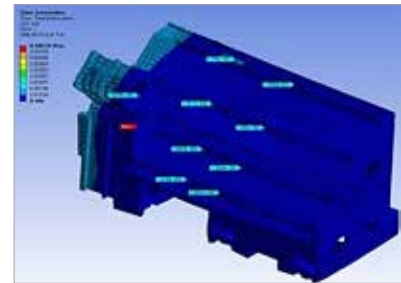

#### Floor Space (L×W)

Standard Bed

**7,077×3,075** mm (278.6"×121.1")

Long Type Bed

**8,715×3,075** mm (343.1"×121.1")

## GUIDEWAY

### Box Guideway

The L600/700/800 Series, specialized in machining large products, features box guideways in all axes and gear driven main spindle. The series demonstrates unsurpassed performance in heavy duty cutting.

### Ball Screw

Travel is stabilized by fixing both ends of the ball screw with double anchored method. In particular, a large diameter ball screw with proper preload reinforces sturdiness and resistance to thermal displacement.



#### Travel (X/Z)

Standard Bed

**500/1,680** mm (19.7"/66.1")

Long Type Bed

**500/3,280** mm (19.7"/129.1")



# 02 HIGH PRECISION SPINDLE

Long Lasting, High Accuracy & Excellent Performance CNC Turning Center

## Spindle Specifications

MODEL	Spindle Speed	Motor (Max./Cont.)	Torque (Max./Cont.)	Driving Method
L600 Series	1,800 rpm	45/37 kW (60/50 HP)	5,610/4,621 N·m (4,137.7/3,408.3 lbft·ft)	Belt + 3 Step Gear
L700 Series	1,500 rpm	45/37 kW (60/50 HP)	6,928/5,700 N·m (5,109.8/4,204.1 lbft·ft)	
L800 Series	700 rpm	45/37 kW (60/50 HP)	7,045/5,795 N·m (5,196.1/4,274.2 lbft·ft)	Belt + 2 Step Gear
L800D Series	500 rpm	45/37 kW (60/50 HP)	7,288/5,992 N·m (5,375.4/4,419.5 lbft·ft)	

# HEAVY DUTY CUTTING & HIGH ACCURACY

## MAIN SPINDLE

### Spindle Ideal for Heavy Cutting

To accomplish advanced stability during heavy duty cutting, a combination of P4 double cylindrical roller bearings and angular bearings are adopted. The double locking device separates the spindle bearing and pulley to prevent a decrease in spindle bearing pretension during interrupted cutting, heavy duty cutting, chuck cylinder operations, and by belt pulley tension.

#### Spindle Gear Box

Gear shift of spindle provide stability and high torque during low speed.

L600/700 Series

L800 Series

3 Step Gear

2 Step Gear

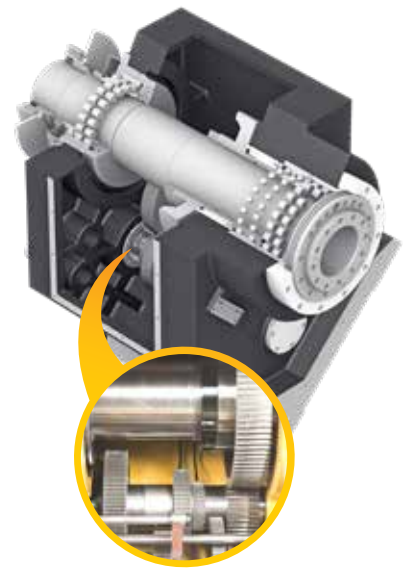

### C-Axis Control ('M' Type)

The C-axis is capable of 0.001° control when milling turret is applied. Machining capability is strengthened with turning and milling operations.

※ Prior consultation is required when applying spindle contouring control for gear driven spindle.

## BIG BORE SPINDLE (L800/D Series)

Max. Spindle Bore L800LMA :  $\varnothing 320$  ( $\varnothing 12.6''$ ), L800D :  $\varnothing 375$  ( $\varnothing 14.8''$ ) show excellent performance in machining large cylindrical parts for oil and gas industry.

### Air Chucking System **OPTION**

A dual chuck design – one on each end of the spindle – offers superior support of the workpiece such as long shafts or pipe.





# 03 SERVO TURRET

High speed, High Accuracy, Highly Reliable Servo Turret

## Servo Turret

No. of Tools

12<sub>EA</sub>

Tool Size (O.D/i.D)

□ 32/Ø80<sub>mm</sub> (Ø1 1/4"/Ø3")

Indexing Time

0.4<sub>sec</sub>

## Mill Turret

ITEM	Speed	Motor (Max./Cont)	Torque (Max./Cont)	Collet Size
BMT85	3,000 rpm (FANUC)	11/7.5 kW (15/10HP)	140/95.4 N·m (103.3/70.4 lbf·ft)	ER50 / Ø34 (1.3")



# VARIOUS DRIVEN PRECISION BMT TOOL HOLDERS

## SERVO TURRET



### Standard Turret

The L600/700/800 Series apply an AC Servo Motor to enhance machining reliability. Also, split accuracy is improved by using 3-piece couplings. Powerful hydraulic tool clamping system minimizes tool tip displacement caused by workload.

### 70 bar High Pressure Coolant **OPTION**

Turret is designed to utilize 70 bar high pressure coolant and it shows optimum performance in machining difficult-to-cut material.

### BMT85 Turret

The BMT turret secures the tool with four bolts and key on the tool mounting surface of the turret, making it possible to powerfully fix the tool, ensuring high reliability in rigidity and precision.

STRAIGHT MILLING HEAD



ANGULAR MILLING HEAD



### Mill Tool Holder

Machining capability has increased with the addition of straight milling head tool holder.

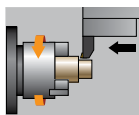

Heavy-duty cutting (O.D)  
(Material : S45C)

Spindle rpm	96 r/min
Cutting speed	150 m/min
Cutting depth	12 mm
Forwarding	0.65 mm/rev
Chip discharge	1,170 cc/min

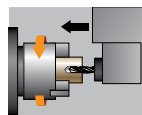

U-Drilling  
(Material : S45C)

Tool diameter	Ø180
Cutting speed	130 m/min
Cutting depth	50 mm
Forwarding	0.14 mm/rev
Chip discharge	814 cc/min

❖ The above result might be different by types of processing circumstance.

# 04 USER CONVENIENCE

Various Devices for User Friendly

## TAIL STOCK

### Built-In Tail Stock

The built-in tail stock ensures high accuracy even during heavy duty cutting and can be controlled automatically or manually.



Taper	Quill Dia.	Quill Travel
MT#6	Ø160 mm (6.3")	132.5 mm (5.2")

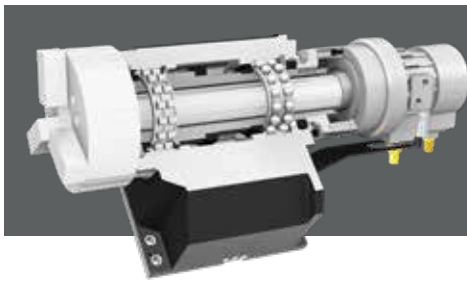

### Chuck Type Tail Stock **OPTION**

When machining material like pipe stable product-machining is possible with the use of chuck type tail stock.

Chuck Size : 12"	Sp. Speed : 3,000 rpm	Quill Dia. : Ø95 mm (Ø3.7")
------------------	-----------------------	-----------------------------

## MACHINING SUPPORT SYSTEM



### Automatic Q-Setter

Cutting tools are calibrated quickly and accurately with the addition of a q-setter. Each tool tip is touched off manually using a sensor that inputs the position automatically.

※ (L800/D Series : Manual Q-Setter)



### Steady Rest **OPTION**

For long parts, such as shafts, the steady rest increases rigidity and minimizes vibration. (Manual/Programmable hydraulic steady rest)



### Rear Chuck **OPTION**

The rear chuck option enables long products such as long shaft or pipes to be processed in a stable condition.

Optional

## CHIP DISPOSAL SOLUTION

### Chip Conveyor

Timely and effective disposal of chips will enhance productivity as well as the working environment.



Hinge	Chip Type : Roughing Chip, Long Chip, Chip complex	Material : SS41, 45C, Cast Steel	Front Right Direction
	Highly efficient when disposing a lot of chips. Capable of handling stringy chips..		
Scraper	Chip Type : Finely broken chip blown out	Material : cast Iron, Nonferrous	
	Convenient for shortly cut chips.		
❖ Screw	Chip Type : The lower portion of micro-chips	Material : Steel, Casting	
	Compresses and ejects chips to reduce chip Trouble.		
❖ Drum Filter	Chip Type : Powder, Micro Chip	Material : AL	
	Advantageous in precision, as the chips do not flow in to the coolant nozzle.		

❖ When ordering a screw or drum filter chip conveyor, prior consult with hyundai wia's sales person.

## COOLANT UNIT & ECO SYSTEM



Standard Coolant (Nozzle)



Chuck Coolant (Upper Chuck)



Chuck Air Blow (Upper Chuck)



Air Gun

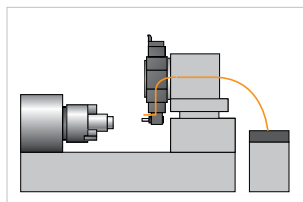

MQL : Minimal Quantity Lubrication



Oil Skimmer



Mist Collector



Oil Lubrication Device



# 05 HYUNDAI WIA FANUC – SMART PLUS

The Compatible All-round Control



## 15" Touch-type Monitor as a standard

	Fast Cycle Time Technology
Smart Machine Control	Fine Surface Technology
	Smart Servo Control Technology
Conversational Program	SmartGuide-i
i-HMI	Machining-aid Function
Part Program Storage	5120M (2MB)
No. of Registerable Programs	1000 EA



# SMART SOFTWARE



## Dialogue Program (Smart Guide-i)

This software offers the maximum user convenience through dialogue manipulation from setup to processing. This includes writing processing programs and simulation checks.

## Convenience Function S/W

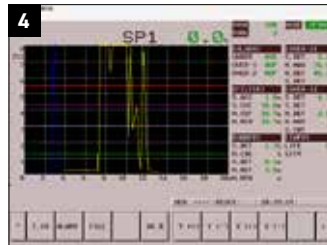

### 1. Thermal Displacement Compensation (HW-TDC) **OPTION**

This software improves processing precision by minimizing thermal deformation from changes in external environments and machining.

### 2. Machine Guidance (HW-MCG)

This software offers various user convenience functions such as tool manipulation, maintenance, tool monitoring, and a pop-up/status

### 3. LAUNCHER

This software offers shortcuts for quick access to specialized features and frequently used features.

### 4. Tool Monitoring (HW-TM) **OPTION**

This tool status monitoring software monitors and protects workpiece, tools, and equipment through real-time monitoring of the motor load from machining.

## Machining Support S/W



### 1. Premium Tool Operation

This software offers premium graphic functions for more intuitive tool operation. (Only in iHMI tools)

### 2. Manual Viewer

This software enables users to view electronic manuals right from the tool. (Only in iHMI tools)

### 3. Scheduling

This software enables viewing/setting up directly from the tool. This allows such actions as managing customer's tool schedules and schedule notification. (Only in iHMI tools)

### 4. Operation Memo

This software is capable of managing customer notes such as tool information and issues. (Only in iHMI tools)

# SPECIFICATIONS

## Standard & Optional

● : Standard ○ : Option ☆ : Prior Consultation - : Non Applicable

Spindle		L600A(LA)	L600MA(LMA)
Main Spindle Hollow Chuck 3 Jaw	18"	○	○
	21"	○	○
	24"	-	-
Main Spindle Solid Chuck 3 Jaw	18"	-	-
	21"	-	-
Standard Soft Jaw (1set)		○	○
Chuck Clamp Foot Switch		●	●
2 Steps Hyd. Pressure Device		○	○
Spindle Inside Stopper		☆	☆
5" Index		☆	☆
Cs-Axis (0.001")		-	-
Chuck Open/Close Confirmation Device		●	●
2 Steps Chuck Foot Switch		○	○
<b>Turret</b>			
Tool Holder		●	●
Mill Turret	BMT	-	●
Straight Milling Head (Radial)	Adaptor Type	-	●
Angular Milling Head (Axial)	Adaptor Type	-	●
Boring Sleeve		●	●
Drill Socket		○	○
U-Drill Cap		●	●
Long Boring Bar I.D Holder		LA ☆	LMA ☆
Angle Head		-	☆
<b>Tail Stock &amp; Steady Rest</b>			
Built-In Tail Stock		●	●
Programmable Tail Stock		●	●
Manual Type Steady Rest		☆	☆
Manual Type Hyd. Steady Rest	1Set	-	-
	2Sets	-	-
Programmable Hyd. Steady Rest	1Set	○	○
	2Sets	LA ○	LMA ○
Fixed center		●	●
2 Steps Tail Stock Pressure System		☆	☆
Quill Forward/Reverse Confirmation Device		○ (CE:●)	○ (CE:●)
Tail Stock Foot Switch (Standard when selecting the tailstock / Excluding the motor tailstock)		●	●
<b>Coolant &amp; Air Blow</b>			
Standard Coolant (Nozzle)		●	●
Bed Flushing Coolant		●	●
Chuck Coolant (Upper Chuck)		○	○
Gun Coolant		○	○
Spindle Thru Coolant (Only for Special Chuck)		☆	☆
Thru Coolant for Live Tool		-	-
Chuck Air Blow (Upper Chuck)		○	○
Tail Stock Air Blow (Upper Tail Stock)		☆	☆
Turret Air Blow		☆	☆
Air Gun		○	○
Spindle Thru Air Blow (Only for Special Chuck)		☆	☆
High Pressure Coolant	6Bar	●	●
	20Bar	○	○
	70Bar	○	○
Power Coolant System (For Automation)		☆	☆
Coolant Chiller		☆	☆
<b>Chip Disposal</b>			
Coolant Tank	570 ℓ (150.6 gal)	●	●
	770 ℓ (203.4 gal)	LA ●	LMA ●
Chip Conveyor (Hinge/Scraper)	Front (Right)	○	○
	Front (Rear)	-	-
Special Chip Conveyor (Drum Filter)		☆	☆
Chip Wagon	Standard (180 ℓ [47.5 gal])	○	○
	Swing (200 ℓ [52.8 gal])	○	○
	Large Swing (290 ℓ [76.6 gal])	○	○
	Large Size (330 ℓ [87.2 gal])	○	○
Customized		☆	☆

Safety Device		L600A(LA)	L600MA(LMA)
Total Splash Guard		●	●
Chuck hydraulic pressure maintenance interlock		○ (CE:●)	○ (CE:●)
<b>Electric Device</b>			
Call Light	1Color : ●	●	●
Call Light & Buzzer	3Color : ● ● ● B	○	○
Electric Cabinet Light		○	○
Remote MPG		○	○
Work Counter	Digital	○	○
Total Counter	Digital	○	○
Tool Counter	Digital	○	○
Multi Tool Counter	Digital	○	○
Electric Circuit Breaker		○	○
AVR (Auto Voltage Regulator)		☆	☆
Transformer	70kVA	○	○
Auto Power Off		○	○
<b>Measurement</b>			
Q-Setter		-	-
Automatic Q-Setter		●	●
Work Close Confirmation Device (Only for Special Chuck)	TACO	☆	☆
	SMC	☆	☆
Work Setter		○	○
Linear Scale	X Axis	○	○
	Z Axis	○	○
Coolant Level Sensor (Only for Chip Conveyor)		☆	☆
<b>Environment</b>			
Air Conditioner		○	○
Oil Mist Collector		☆	☆
Oil Skimmer		○	○
MQL (Minimal Quantity Lubrication)		☆	☆
<b>Fixture &amp; Automation</b>			
Auto Door	Standard	○	○
	High Speed	☆	☆
Auto Shutter (Only for Automatic System)		-	-
Sub Operation Pannel		☆	☆
Bar Feeder Interface		○	○
Bar Feeder (FEDEK)		☆	☆
Extra M-Code 4ea		○	○
Automation Interface		☆	☆
I/O Extension (IN & OUT)	16 Contact	○	○
	32 Contact	○	○
Parts Catcher	Main SP.	-	-
Turret Work Pusher (For Automation)		☆	☆
<b>Hyd. Device</b>			
Standard Hyd. Cylinder	Hollow	●	●
Standard Hyd. Unit	58bar/63 ℓ (16.6 gal)	●	●
<b>S/W</b>			
DNC software (HW-eDNC)		○	○
Machine Monitoring System (HW-MMS Cloud/Edge/Remote)		○	○
Machine Monitoring System & Analysis (HW-MMS Edge Plus)		☆	☆
Automation CAM program (HW-ACAM)		○	-
Conversational program (HW-DPRO)		○	○
SmartGuide-i : FANUC		●	●
Thermal Displacement Compensation (HW-TDC)		○	○
Tool Monitoring (HW-TM) : FANUC		○	○
Machine Guidance (HW-MCG) : FANUC		●	●
Energy Saving System (HW-ESS) : FANUC		●	●
Premium Tool Operation : FANUC		● (F32i : -)	● (F32i : -)
Manual Viewer : FANUC		● (F32i : -)	● (F32i : -)
Scheduling : FANUC		● (F32i : -)	● (F32i : -)
Operation Memo : FANUC		● (F32i : -)	● (F32i : -)
<b>ETC</b>			
Tool Box		●	●
Customized Color	Need Munsel No.	☆	☆
CAD & CAM		☆	☆

❖ 4 channel of TDC(Thermal Displacement Compensation) device is recommended, when more than 6 bar of high pressure coolant is applied, for the high quality machining.  
Specifications are subject to change without notice for improvement.



# SPECIFICATIONS

## Standard & Optional

Spindle		L700A(LA)	L700MA(LMA)
Main Spindle Hollow Chuck 3 Jaw	18"	-	-
	21"	-	-
	24"	○	○
Main Spindle Solid Chuck 3 Jaw	18"	-	-
	21"	-	-
	24"	-	-
Standard Soft Jaw (1set)		○	○
Chuck Clamp Foot Switch		●	●
2 Steps Hyd. Pressure Device		○	○
Spindle Inside Stopper		☆	☆
5° Index		☆	☆
Cs-Axis (0.001°)		-	●
Chuck Open/Close Confirmation Device		●	●
2 Steps Chuck Foot Switch		○	○
<b>Turret</b>			
Tool Holder		●	●
Mill Turret	BMT	-	●
Straight Milling Head (Radial)	Adaptor Type	-	●
Angular Milling Head (Axial)	Adaptor Type	-	●
Boring Sleeve		●	●
Drill Socket		○	○
U-Drill Cap		●	●
Long Boring Bar I.D Holder		LA ☆	LMA ☆
Angle Head		-	☆
<b>Tail Stock &amp; Steady Rest</b>			
Built-In Tail Stock		●	●
Programmable Tail Stock		●	●
Manual Type Steady Rest		☆	☆
Manual Type Hyd. Steady Rest	1Set	-	-
	2Sets	-	-
Programmable Hyd. Steady Rest	1Set	○	○
	2Sets	LA ○	LMA ○
Fixed center		●	●
2 Steps Tail Stock Pressure System		☆	☆
Quill Forward/Reverse Confirmation Device		○(CE:●)	○(CE:●)
Tail Stock Foot Switch (Standard when selecting the tailstock / Excluding the motor tailstock)		●	●
<b>Coolant &amp; Air Blow</b>			
Standard Coolant (Nozzle)		●	●
Bed Flushing Coolant		●	●
Chuck Coolant (Upper Chuck)		○	○
Gun Coolant		○	○
Spindle Thru Coolant (Only for Special Chuck)		☆	☆
Thru Coolant for Live Tool		-	-
Chuck Air Blow (Upper Chuck)		○	○
Tail Stock Air Blow (Upper Tail Stock)		☆	☆
Turret Air Blow		☆	☆
Air Gun		○	○
Spindle Thru Air Blow (Only for Special Chuck)		☆	☆
High Pressure Coolant	6Bar	●	●
	20Bar	○	○
	70Bar	○	○
Power Coolant System (For Automation)		☆	☆
Coolant Chiller		☆	☆
<b>Chip Disposal</b>			
Coolant Tank	570 ℓ (150.6 gal)	●	●
	770 ℓ (203.4 gal)	LA ●	LMA ●
Chip Conveyor (Hinge/Scraper)	Front (Right)	○	○
	Front (Rear)	-	-
Special Chip Conveyor (Drum Filter)		☆	☆
Chip Wagon	Standard (180 ℓ [47.5 gal])	○	○
	Swing (200 ℓ [52.8 gal])	○	○
	Large Swing (290 ℓ [76.6 gal])	○	○
	Large Size (330 ℓ [87.2 gal])	○	○
	Customized	☆	☆

● : Standard ○ : Option ☆ : Prior Consultation - : Non Applicable

Safety Device		L700A(LA)	L700MA(LMA)
Total Splash Guard		●	●
Chuck hydraulic pressure maintenance interlock		○(CE:●)	○(CE:●)
<b>Electric Device</b>			
Call Light	1Color : ●	●	●
Call Light & Buzzer	3Color : ● ■ ■ B	○	○
Electric Cabinet Light		○	○
Remote MPG		○	○
Work Counter	Digital	○	○
Total Counter	Digital	○	○
Tool Counter	Digital	○	○
Multi Tool Counter	Digital	○	○
Electric Circuit Breaker		○	○
AVR (Auto Voltage Regulator)		☆	☆
Transformer	70kVA	○	○
Auto Power Off		○	○
<b>Measurement</b>			
Q-Setter		-	-
Automatic Q-Setter		●	●
Work Close Confirmation Device (Only for Special Chuck)	TACO	☆	☆
	SMC	☆	☆
Work Setter		○	○
Linear Scale	X Axis	○	○
	Z Axis	○	○
Coolant Level Sensor (Only for Chip Conveyor)		☆	☆
<b>Environment</b>			
Air Conditioner		○	○
Oil Mist Collector		☆	☆
Oil Skimmer		○	○
MQL (Minimal Quantity Lubrication)		☆	☆
<b>Fixture &amp; Automation</b>			
Auto Door	Standard	○	○
	High Speed	☆	☆
Auto Shutter (Only for Automatic System)		-	-
Sub Operation Pannel		☆	☆
Bar Feeder Interface		○	○
Bar Feeder (FEDEK)		☆	☆
Extra M-Code 4ea		○	○
Automation Interface		☆	☆
I/O Extension (IN & OUT)	16 Contact	○	○
	32 Contact	○	○
Parts Catcher	Main SP	-	-
Turret Work Pusher (For Automation)		☆	☆
<b>Hyd. Device</b>			
Standard Hyd. Cylinder	Hollow	●	●
Standard Hyd. Unit	58bar/63 ℓ (16.6 gal)	●	●
<b>S/W</b>			
DNC software (HW-eDNC)		○	○
Machine Monitoring System (HW-MMS Cloud/Edge/Remote)		○	○
Machine Monitoring System & Analysis (HW-MMS Edge Plus)		☆	☆
Automation CAM program (HW-ACAM)		○	-
Conversational program (HW-DPRO)		○	○
SmartGuide-i : FANUC		●	●
Thermal Displacement Compensation (HW-TDC)		○	○
Tool Monitoring (HW-TM) : FANUC		○	○
Machine Guidance (HW-MCG) : FANUC		●	●
Energy Saving System (HW-ESS) : FANUC		●	●
Premium Tool Operation : FANUC		● (F32i : -)	● (F32i : -)
Manual Viewer : FANUC		● (F32i : -)	● (F32i : -)
Scheduling : FANUC		● (F32i : -)	● (F32i : -)
Operation Memo : FANUC		● (F32i : -)	● (F32i : -)
<b>ETC</b>			
Tool Box		●	●
Customized Color	Need Munsel No.	☆	☆
CAD & CAM		☆	☆

❖ 4 channel of TDC(Thermal Displacement Compensation) device is recommended, when more than 6 bar of high pressure coolant is applied, for the high quality machining.  
Specifications are subject to change without notice for improvement.

# SPECIFICATIONS

## Standard & Optional

● : Standard ○ : Option ☆ : Prior Consultation - : Non Applicable

Spindle		L800A(LA)	L800MA(LMA)
Main Spindle Hollow Chuck 3 Jaw	18"	-	-
	21"	-	-
	24"	-	-
	32"	○	○
Main Spindle Solid Chuck 3 Jaw	18"	-	-
	21"	-	-
	24"	-	-
	32"	-	-
Big Bore Air Chuck	27"	○	○
Standard Soft Jaw (1set)		○	○
Chuck Clamp Foot Switch		●	●
2 Steps Hyd. Pressure Device		○	○
Spindle Inside Stopper		☆	☆
5" Index		☆	☆
Cs-Axis (0.001")		-	●
Chuck Open/Close Confirmation Device		●	●
2 Steps Chuck Foot Switch		○	○
<b>Turret</b>			
Tool Holder		●	●
Mill Turret	BMT	-	●
Straight Milling Head (Radial)	Adaptor Type	-	●
Angular Milling Head (Axial)	Adaptor Type	-	●
Boring Sleeve		●	●
Drill Socket		○	○
U-Drill Cap		●	●
Long Boring Bar I.D Holder		LA ☆	LMA ☆
Angle Head		-	☆
<b>Tail Stock &amp; Steady Rest</b>			
Built-In Tail Stock		●	●
Programmable Tail Stock		●	●
Manual Type Steady Rest		☆	☆
Manual Type Hyd. Steady Rest	1Set	-	-
	2Sets	-	-
Programmable Hyd. Steady Rest	1Set	○	○
	2Sets	LA ○	LMA ○
Fixed center		●	●
2 Steps Tail Stock Pressure System		☆	☆
Quill Forward/Reverse Confirmation Device		○ (CE:●)	○ (CE:●)
Tail Stock Foot Switch (Standard when selecting the tailstock / Excluding the motor tailstock)		●	●
<b>Coolant &amp; Air Blow</b>			
Standard Coolant (Nozzle)		●	●
Bed Flushing Coolant		●	●
Chuck Coolant (Upper Chuck)		○	○
Gun Coolant		○	○
Spindle Thru Coolant (Only for Special Chuck)		☆	☆
Thru Coolant for Live Tool		-	-
Chuck Air Blow (Upper Chuck)		○	○
Tail Stock Air Blow (Upper Tail Stock)		☆	☆
Turret Air Blow		☆	☆
Air Gun		○	○
Spindle Thru Air Blow (Only for Special Chuck)		☆	☆
High Pressure Coolant	6Bar	●	●
	20Bar	○	○
	70Bar	○	○
Power Coolant System (For Automation)		☆	☆
Coolant Chiller		☆	☆
<b>Chip Disposal</b>			
Coolant Tank	570 ℓ (150.6 gal)	●	●
	770 ℓ (203.4 gal)	LA ●	LMA ●
Chip Conveyor (Hinge/Scraper)	Front (Right)	○	○
	Front (Rear)	-	-
Special Chip Conveyor (Drum Filter)		☆	☆
Chip Wagon	Standard (180 ℓ [47.5 gal])	○	○
	Swing (200 ℓ [52.8 gal])	○	○
	Large Swing (290 ℓ [76.6 gal])	○	○
Chip Wagon	Large Size (330 ℓ [87.2 gal])	○	○
	Customized	☆	☆

Safety Device		L800A(LA)	L800MA(LMA)
Total Splash Guard		●	●
Chuck hydraulic pressure maintenance interlock		○ (CE:●)	○ (CE:●)
<b>Electric Device</b>			
Call Light	1Color : ●	●	●
Call Light & Buzzer	3Color : ● ● ● B	○	○
Electric Cabinet Light		○	○
Remote MPG		○	○
Work Counter	Digital	○	○
Total Counter	Digital	○	○
Tool Counter	Digital	○	○
Multi Tool Counter	Digital	○	○
Electric Circuit Breaker		○	○
AVR (Auto Voltage Regulator)		☆	☆
Transformer	70kVA	○	○
Auto Power Off		○	○
<b>Measurement</b>			
Q-Setter		○	○
Automatic Q-Setter		-	-
Work Close Confirmation Device (Only for Special Chuck)	TACO	☆	☆
	SMC	☆	☆
Work Setter		○	○
Linear Scale	X Axis	○	○
	Z Axis	○	○
Coolant Level Sensor (Only for Chip Conveyor)		☆	☆
<b>Environment</b>			
Air Conditioner		○	○
Oil Mist Collector		☆	☆
Oil Skimmer		○	○
MQL (Minimal Quantity Lubrication)		☆	☆
<b>Fixture &amp; Automation</b>			
Auto Door	Standard	○	○
	High Speed	☆	☆
Auto Shutter (Only for Automatic System)		-	-
Sub Operation Pannel		☆	☆
Bar Feeder Interface		○	○
Bar Feeder (FEDEK)		☆	☆
Extra M-Code 4ea		○	○
Automation Interface		☆	☆
I/O Extension (IN & OUT)	16 Contact	○	○
	32 Contact	○	○
Parts Catcher	Main SP.	-	-
Turret Work Pusher (For Automation)		☆	☆
<b>Hyd. Device</b>			
Standard Hyd. Cylinder	Hollow	○	○
Standard Hyd. Unit	58bar/63 ℓ (16.6 gal)	●	●
<b>S/W</b>			
DNC software (HW-eDNC)		○	○
Machine Monitoring System (HW-MMS Cloud/Edge/Remote)		○	○
Machine Monitoring System & Analysis (HW-MMS Edge Plus)		☆	☆
Automation CAM program (HW-ACAM)		○	-
Conversational program (HW-DPRO)		○	○
SmartGuide-i : FANUC		●	●
Thermal Displacement Compensation (HW-TDC)		○	○
Tool Monitoring (HW-TM) : FANUC		○	○
Machine Guidance (HW-MCG) : FANUC		●	●
Energy Saving System (HW-ESS) : FANUC		●	●
Premium Tool Operation : FANUC		● (F32i : -)	● (F32i : -)
Manual Viewer : FANUC		● (F32i : -)	● (F32i : -)
Scheduling : FANUC		● (F32i : -)	● (F32i : -)
Operation Memo : FANUC		● (F32i : -)	● (F32i : -)
<b>ETC</b>			
Tool Box		●	●
Customized Color	Need Munsel No.	☆	☆
CAD & CAM		☆	☆

❖ 4 channel of TDC(Thermal Displacement Compensation) device is recommended, when more than 6 bar of high pressure coolant is applied, for the high quality machining.

Specifications are subject to change without notice for improvement.

# SPECIFICATIONS

## Standard & Optional

● : Standard ○ : Option ☆ : Prior Consultation - : Non Applicable

Spindle		L800D(LD)	L800MD(LMD)
Main Spindle Hollow Chuck 3 Jaw	18"	-	-
	21"	-	-
	24"	-	-
	32"	-	-
Main Spindle Solid Chuck 3 Jaw	18"	-	-
	21"	-	-
	24"	-	-
	32"	-	-
Big Bore Air Chuck	34"	○	○
Big Bore Independent Chuck	32"	○	○
Standard Soft Jaw (1set)		○	○
Chuck Clamp Foot Switch		●	●
2 Steps Hyd. Pressure Device		○	○
Spindle Inside Stopper		☆	☆
Main Spindle 5° Index		☆	☆
C-Axis (0.001°)		-	●
Chuck Open/Close Confirmation Device		●	●
2 Steps Chuck Foot Switch		○	○
<b>Turret</b>			
Tool Holder		●	●
Mill Turret	BMT	-	●
Straight Milling Head (Radial)	Collet Type	-	●
Angular Milling Head (Axial)	Collet Type	-	●
Boring Sleeve		●	●
Drill Socket		○	○
U-Drill Cap		●	●
Long Boring Bar I.D Holder		LD ☆	LMD ☆
Angle Head		-	☆
<b>Tail Stock &amp; Steady Rest</b>			
Built-In Tail Stock		○	○
Programmable Tail Stock		○	○
Manual Type Steady Rest		☆	☆
Programmable Hyd. Steady Rest	1Set	○	○
	2Sets	LD ○	LMD ○
Fixed center	Selecting Tail Stock (●)	Selecting Tail Stock (●)	Selecting Tail Stock (●)
2 Steps Tail Stock Pressure System	Selecting Tail Stock (☆)	Selecting Tail Stock (☆)	Selecting Tail Stock (☆)
Quill Forward/Reverse Confirmation Device	Selecting Tail Stock (●)	Selecting Tail Stock (●)	Selecting Tail Stock (●)
Tail Stock Foot Switch	Selecting Tail Stock (●)	Selecting Tail Stock (●)	Selecting Tail Stock (●)
<b>Coolant &amp; Air Blow</b>			
Standard Coolant (Nozzle)		●	●
Bed Flushing Coolant		●	●
Chuck Coolant (Upper Chuck)		○	○
Gun Coolant		○	○
Spindle Thru Coolant (Only for Special Chuck)		☆	☆
Thru Coolant for Live Tool		-	-
Chuck Air Blow (Upper Chuck)		○	○
Tail Stock Air Blow (Upper Tail Stock)		☆	☆
Turret Air Blow		☆	☆
Air Gun		○	○
Spindle Thru Air Blow (Only for Special Chuck)		☆	☆
High Pressure Coolant	6Bar	●	●
	20Bar	○	○
	70Bar	○	○
Power Coolant System (For Automation)		☆	☆
Coolant Chiller		☆	☆
<b>Chip Disposal</b>			
Coolant Tank	570 ℓ (150.6 gal)	●	●
	770 ℓ (203.4 gal)	LD ●	LMD ●
Chip Conveyor (Hinge/Scraper)	Front (Right)	○	○
	Front (Rear)	-	-
Special Chip Conveyor (Drum Filter)		☆	☆
Chip Wagon	Standard (180 ℓ [47.5 gal])	○	○
	Swing (200 ℓ [52.8 gal])	○	○
Chip Wagon	Large Swing (290 ℓ [76.6 gal])	○	○
	Large Size (330 ℓ [87.2 gal])	○	○
	Customized	☆	☆

Safety Device		L800D(LD)	L800MD(LMD)
Total Splash Guard		●	●
Chuck hydraulic pressure maintenance interlock		○(CE:●)	○(CE:●)
<b>Electric Device</b>			
Call Light	1Color : ●	●	●
Call Light & Buzzer	3Color : ● ● ● B	○	○
Electric Cabinet Light		○	○
Remote MPG		○	○
Work Counter	Digital	○	○
Total Counter	Digital	○	○
Tool Counter	Digital	○	○
Multi Tool Counter	Digital	○	○
Electric Circuit Breaker		○	○
AVR (Auto Voltage Regulator)		☆	☆
Transformer	70kVA	○	○
Auto Power Off		○	○
<b>Measurement</b>			
Q-Setter		○	○
Automatic Q-Setter		-	-
Work Close Confirmation Device (Only for Special Chuck)	TACO	☆	☆
	SMC	☆	☆
Work Setter		○	○
Linear Scale	X Axis	○	○
	Z Axis	○	○
Coolant Level Sensor (Only for Chip Conveyor)		☆	☆
<b>Environment</b>			
Air Conditioner		○	○
Oil Mist Collector		☆	☆
Oil Skimmer		○	○
MQL (Minimal Quantity Lubrication)		☆	☆
<b>Fixture &amp; Automation</b>			
Auto Door	Standard	○	○
	High Speed	☆	☆
Auto Shutter (Only for Automatic System)		-	-
Sub Operation Pannel		☆	☆
Bar Feeder Interface		-	-
Bar Feeder (FEDEK)		-	-
Extra M-Code 4ea		○	○
Automation Interface		☆	☆
I/O Extension (IN & OUT)	16 Contact	○	○
	32 Contact	○	○
Parts Catcher	Main SP.	-	-
Turret Work Pusher (For Automation)		☆	☆
<b>Hyd. Device</b>			
Standard Hyd. Cylinder	Hollow	-	-
Standard Hyd. Unit	58bar/63 ℓ (16.6 gal)	●	●
<b>S/W</b>			
DNC software (HW-eDNC)		○	○
Machine Monitoring System (HW-MMS Cloud/Edge/Remote)		○	○
Machine Monitoring System & Analysis (HW-MMS Edge Plus)		☆	☆
Automation CAM program (HW-ACAM)		○	-
Conversational program (HW-DPRO)		○	○
SmartGuide-i : FANUC		●	●
Thermal Displacement Compensation (HW-TDC)		○	○
Tool Monitoring (HW-TM) : FANUC		○	○
Machine Guidance (HW-MCG) : FANUC		●	●
Energy Saving System (HW-ESS) : FANUC		●	●
Premium Tool Operation : FANUC		● (F32i : -)	● (F32i : -)
Manual Viewer : FANUC		● (F32i : -)	● (F32i : -)
Scheduling : FANUC		● (F32i : -)	● (F32i : -)
Operation Memo : FANUC		● (F32i : -)	● (F32i : -)
<b>ETC</b>			
Tool Box		●	●
Customized Color	Need Munsel No.	☆	☆
CAD & CAM		☆	☆

◆ 4 channel of TDC(Thermal Displacement Compensation) device is recommended, when more than 6 bar of high pressure coolant is applied, for the high quality machining. Specifications are subject to change without notice for improvement.



# SPECIFICATIONS

## Spindle Output/Torque Diagram

### L600 Series 1,800 rpm

Power(kW [HP])

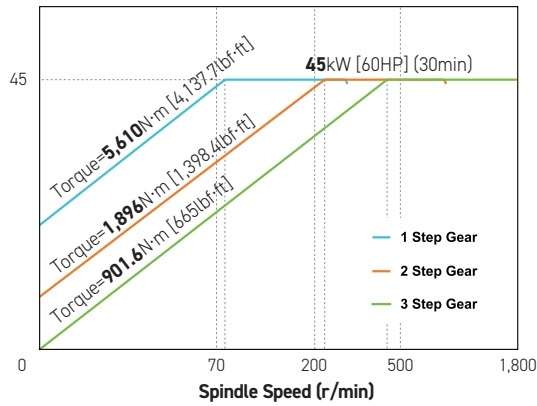

### L700 Series 1,500 rpm

Power(kW [HP])

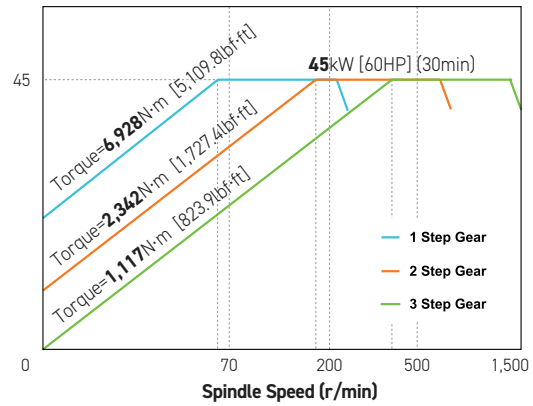

### L800 Series 700 rpm

Power(kW [HP])

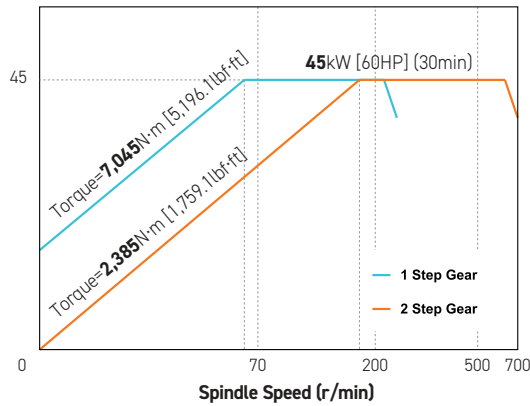

### L800D Series 500 rpm

Power(kW [HP])

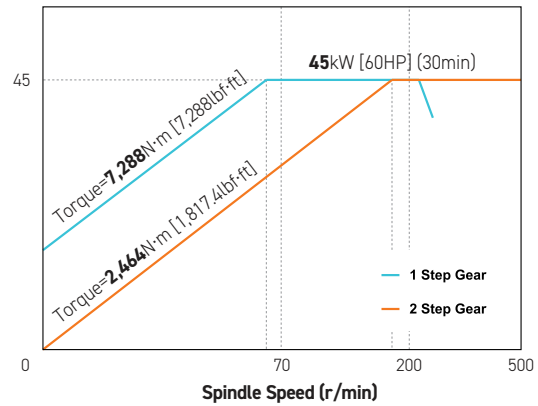

### Mill Turret 3,000 rpm

Power(kW [HP])

Torque (N·m [lbf-ft])

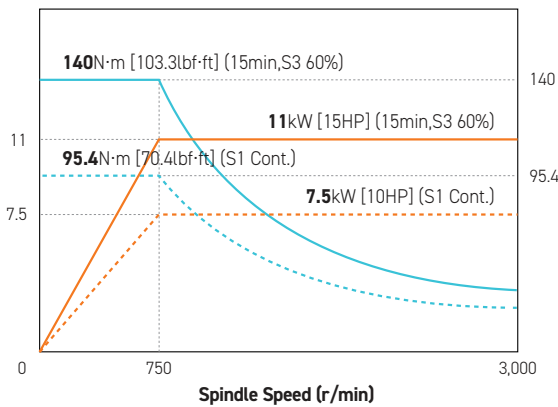

# SPECIFICATIONS

## External Dimensions

unit : mm(in)

### L600A/600MA/700A/700MA/800A/800MA/800D/800MD

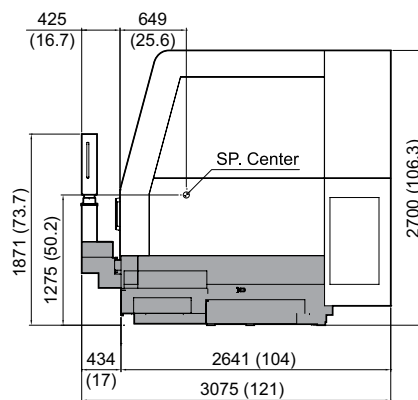
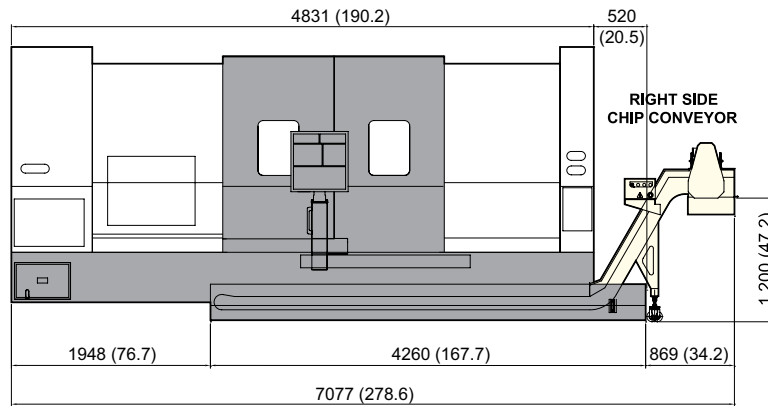
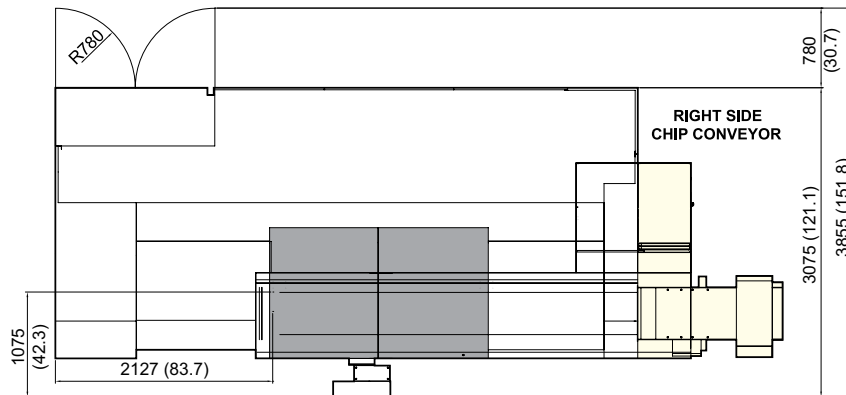

# SPECIFICATIONS

## External Dimensions

unit : mm(in)

L600LA/600LMA/700LA/700LMA/800LA/800LMA/800LD/800LMD

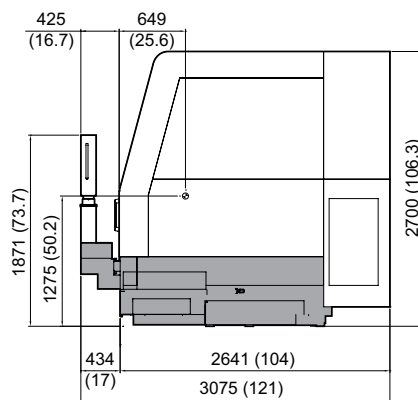
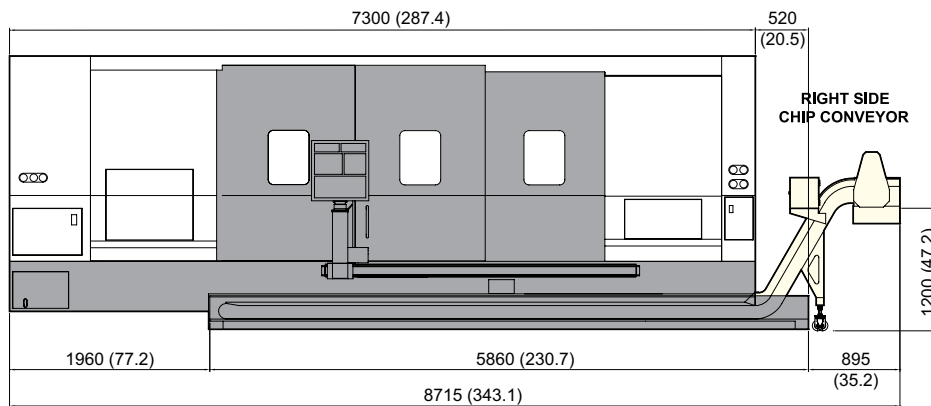
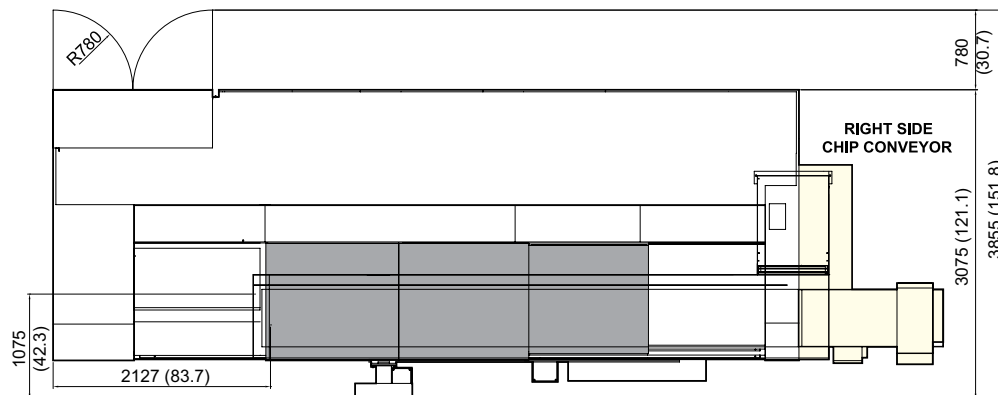



# SPECIFICATIONS

## Interference

unit : mm(in)

### L600A/600LA/700A/700LA/800A/800LA/800D/800LD

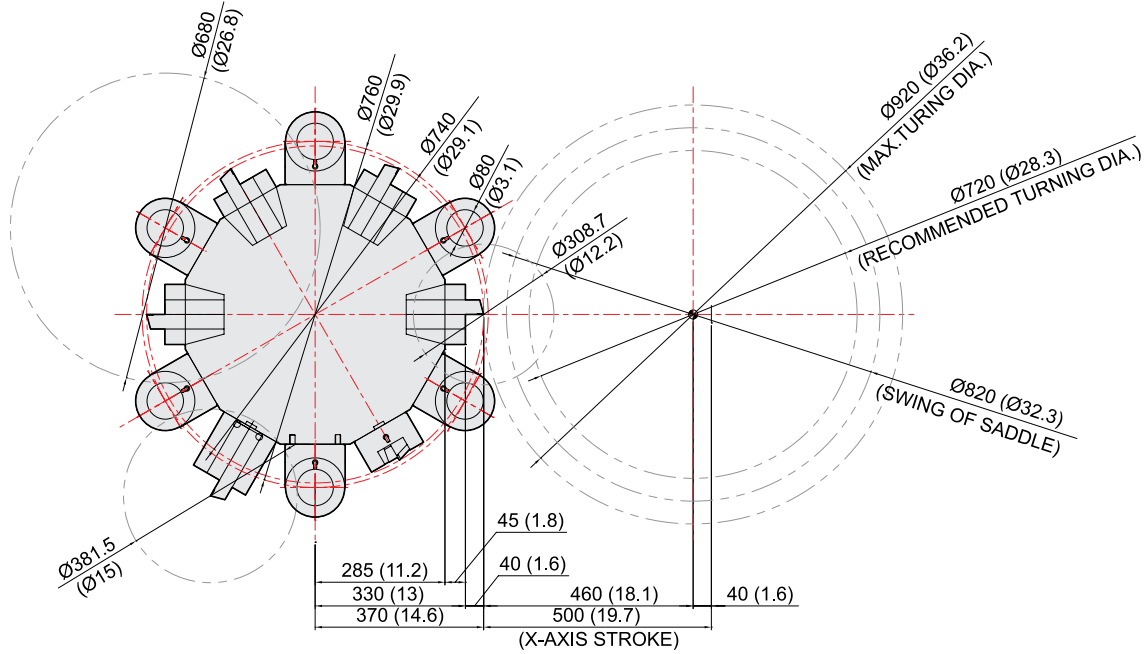

### L600MA/600LMA/700MA/700LMA/800MA/800LMA

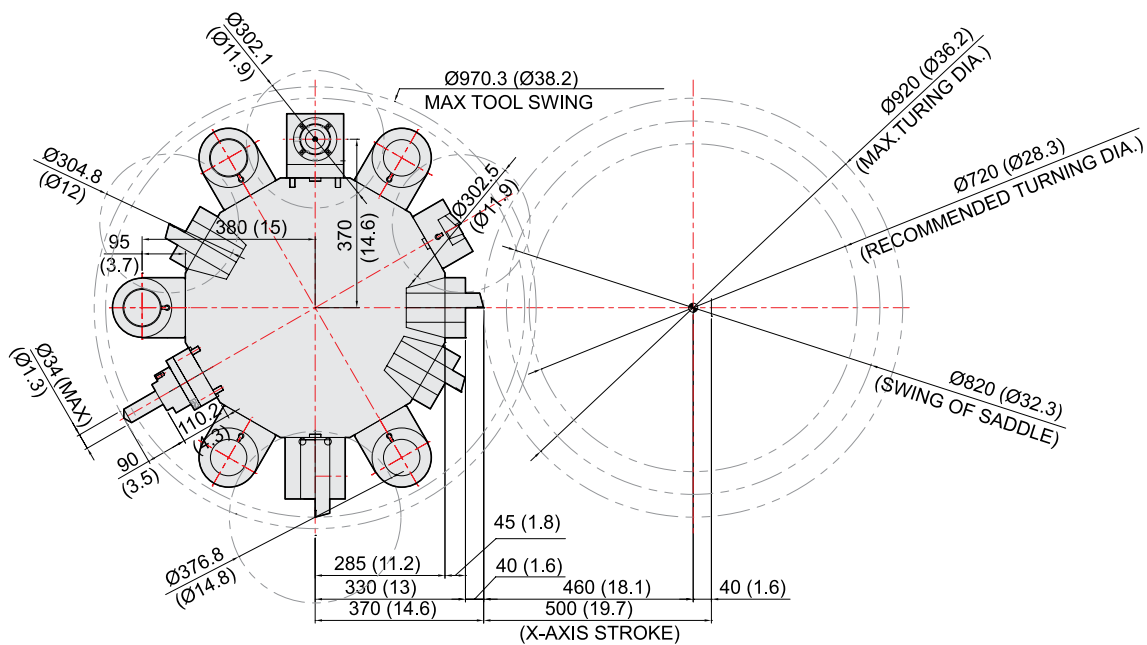

# SPECIFICATIONS

## Tooling System

unit : mm(in)

### L600A/600LA/700A/700LA/800A/800LA/800D/800LD

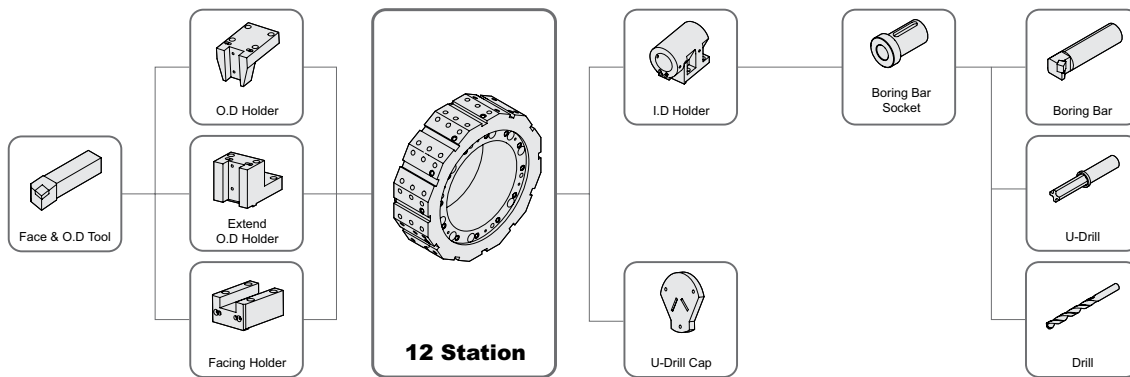

### L600/700/800 Series Tooling Parts Detail

ITEM			A/D		LA/LD	
			mm Unit	inch Unit	mm Unit	inch Unit
Turning Holder	O.D Holder	Right/Left	4	4	4	4
		Extended	1	1	1	1
	Facing Holder		1	1	1	1
Boring Holder	I.D Holder	Single	6	6	6	6
		Long (SET)	-	-	Opt	-
Driven Holder	Straight Mill Holder	Standard	-	-	-	-
	Angular Mill Holder	Standard	-	-	-	-
Socket	Boring	Ø20 (Ø3/4")	1	1	1	1
		Ø25 (Ø1")	1	1	1	1
		Ø32 (Ø1 1/4")	1	1	1	1
		Ø40 (Ø1 1/2")	1	1	1	1
		Ø50 (Ø2")	1	1	1	1
		Ø60 (Ø2 1/4")	1	1	1	1
	Drill	MT 3	Opt	Opt	Opt	Opt
		MT 4	Opt	Opt	Opt	Opt
		MT 5	Opt	Opt	Opt	Opt
	Adapter Set		-	-	-	-

# SPECIFICATIONS

## Tooling System

unit : mm(in)

### L600MA/600LMA/700MA/700LMA/800MA/800LMA/800MD/800LMD

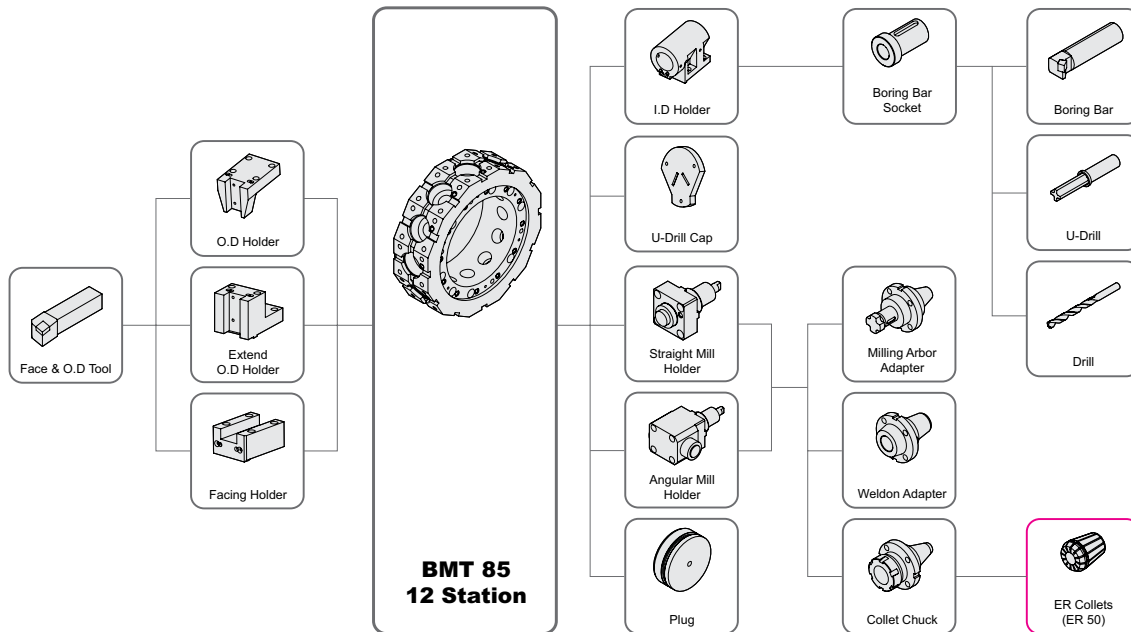

### L600/700/800 Series Tooling Parts Detail

ITEM			MA/MD		LMA/LMD	
			mm Unit	inch Unit	mm Unit	inch Unit
Turning Holder	O.D Holder	Right/Left	3	3	3	3
		Extended	1	1	1	1
	Facing Holder		1	1	1	1
Boring Holder	I.D Holder	Single	5	5	5	5
		Long (SET)	-	-	Opt	-
Driven Holder	Straight Mill Holder	Standard	1	1	1	1
	Angular Mill Holder	Standard	1	1	1	1
Socket	Boring	Ø20 (Ø3/4")	1	1	1	1
		Ø25 (Ø1")	1	1	1	1
		Ø32 (Ø1 1/4")	1	1	1	1
		Ø40 (Ø1 1/2")	1	1	1	1
		Ø50 (Ø2")	1	1	1	1
		Ø60 (Ø2 1/4")	1	1	1	1
	Drill	MT 3	Opt	Opt	Opt	Opt
		MT 4	Opt	Opt	Opt	Opt
		MT 5	Opt	Opt	Opt	Opt
	Adapter Set		1 Set	1 Set	1 Set	1 Set

Specifications are subject to change without notice for improvement. (Driven Holder - EWS : Standard, Eppinger : Option)

# SPECIFICATIONS

Interference

unit : mm(in)

L600A/600MA/700A/700MA/800A/800MA/800D

## OD TOOL HOLDER

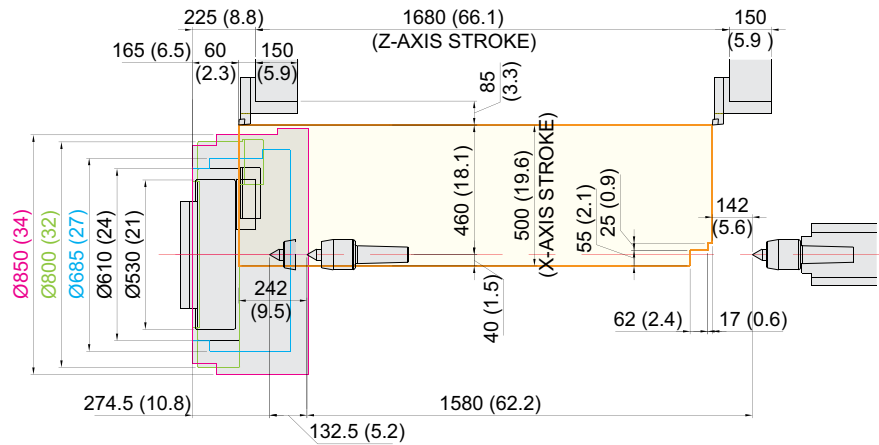

## ID TOOL HOLDER

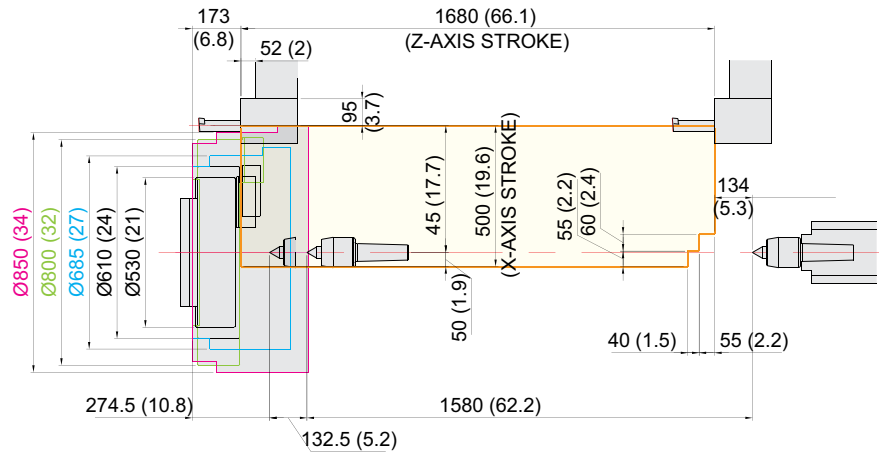

## EXTEND OD TOOL HOLDER

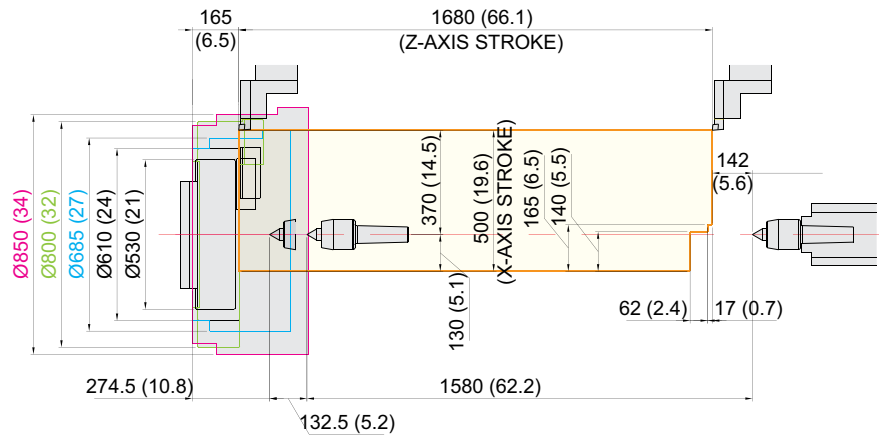



# SPECIFICATIONS

## Tooling Travel Range

unit : mm(in)

L600MA/700MA/800MA/800MD

### STRAIGHT MILLING HEAD

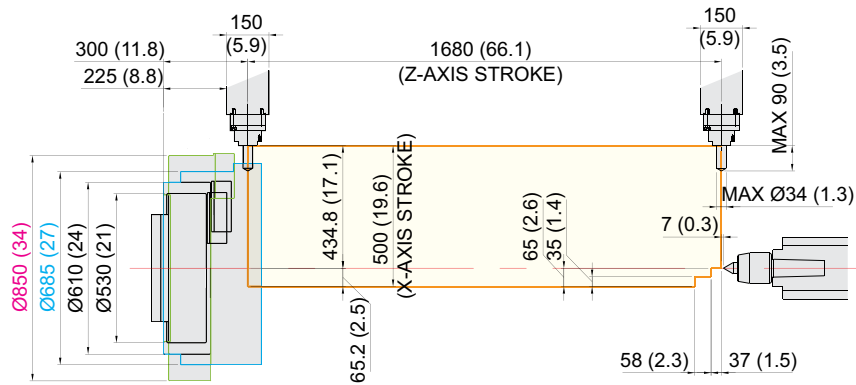

### ANGULAR MILLING HEAD

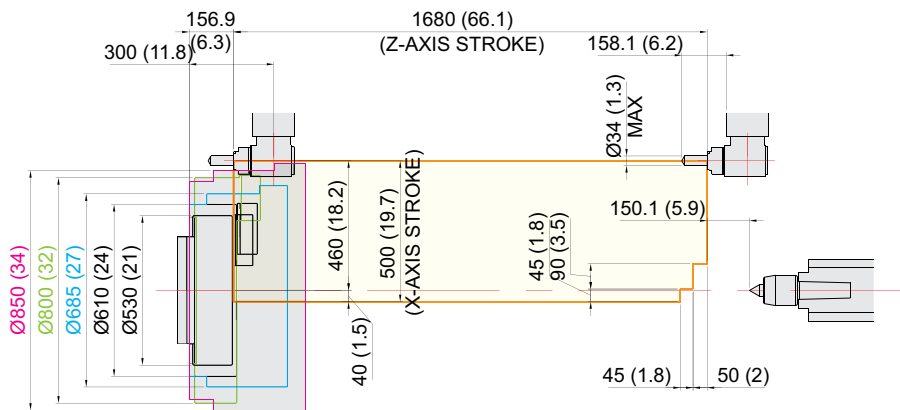

# SPECIFICATIONS

Interference

unit : mm(in)

L600LA/600LMA/700LA/700LMA/800LA/800LMA/800LD/800LMD

## OD TOOL HOLDER

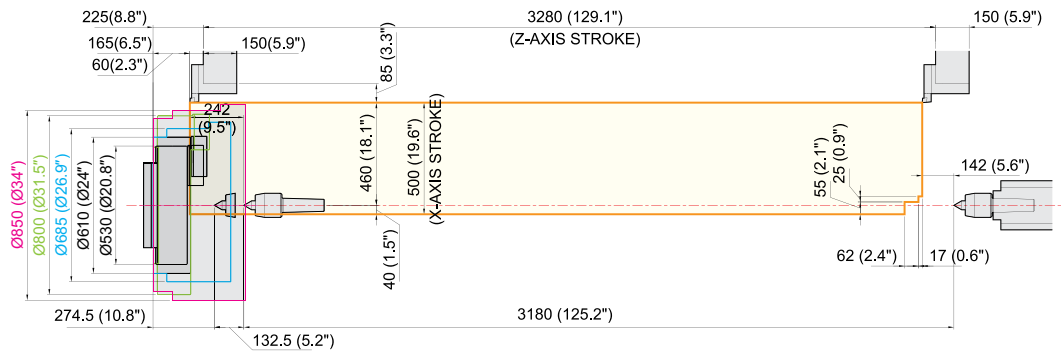

## ID TOOL HOLDER

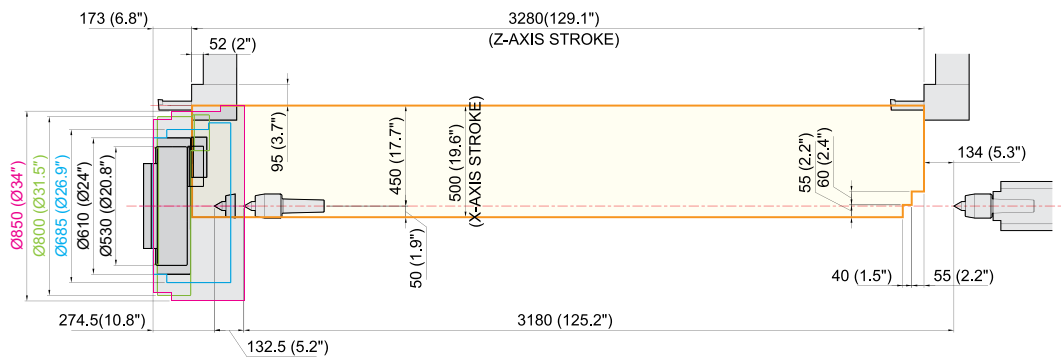

## EXTEND OD TOOL HOLDER

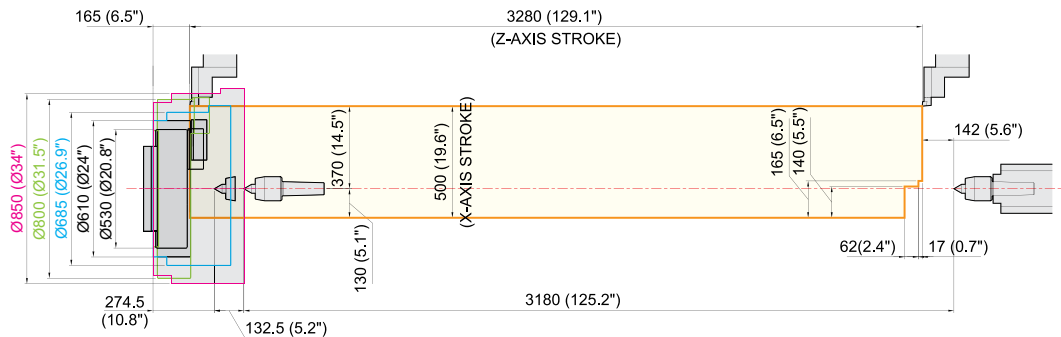

# SPECIFICATIONS

## Tooling Travel Range

unit : mm(in)

L600LMA/700LMA/800LMA/800LMD

### STRAIGHT MILLING HEAD

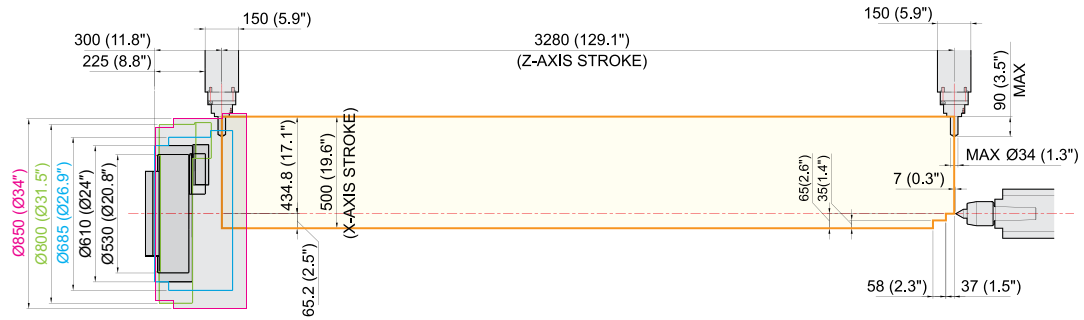

### ANGULAR MILLING HEAD

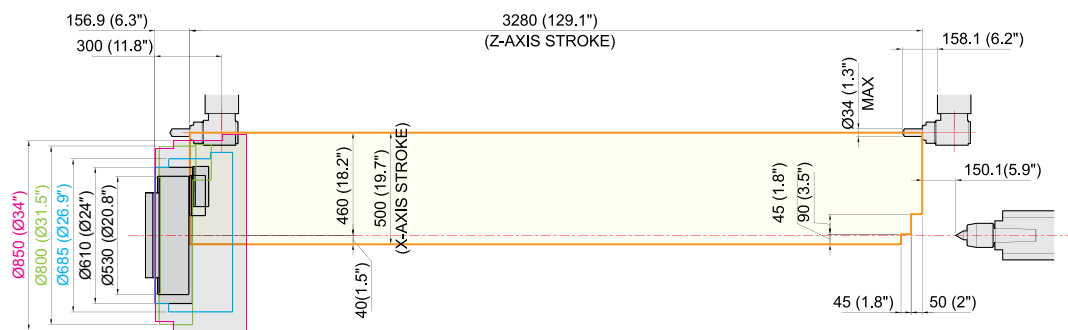

# SPECIFICATIONS

## Specifications

[ ] : Option

ITEM		L600A	L600MA	L600LA	L600LMA	
CAPACITY	Swing Over the Bed	mm(in)	Ø1,050 (41.3")			
	Swing Over the Carriage	mm(in)	Ø820 (32.3")			
	Max. Turning Dia.	mm(in)	Ø920 (36.2")			
	Max. Turning Length	mm(in)	1,650 (65")	3,250 (128")		
	Bar Capacity	mm(in)	{18": Ø117 (Ø4.6")} {21": Ø139 (Ø5.5")}			
SPINDLE	Chuck Size	inch	Opt. [18"/21"]			
	Spindle Bore	mm(in)	Ø152 (6")			
	Spindle Speed (rpm)	r/min	1,800			
	Motor (30min./Cont.)	kW(HP)	45/37 (60/50)			
	Torque (30min./Cont.)	N·m(lbf·ft)	5,610/4,621 (4,137.7/3,408.3)			
	Spindle Type	-	BELT + 3 STEP GEAR			
	Spindle Nose	-	A2-15			
	C-axis Indexing	deg	-	0.001°	-	0.001°
FEED	Travel (X/Z)	mm(in)	500/1,680 (19.7"/66.1")	500/3,280 (19.7"/129.1")		
	Rapid Traverse Rate (X/Z)	m/min	12/16	12/12		
	Slide Type	-	BOX GUIDE			
TURRET	No. of Tools	EA	12			
	Tool Size	OD	□ 32 (1.3")			
		ID	Ø80 (3.1")			
	Indexing Time	sec/step	0.4			
LIVE TOOL	Motor (Max/Cont.)	kW(HP)	-	11/7.5 (14.8/10)	-	11/7.5 (14.8/10)
	Milling Tool Speed (rpm)	r/min	-	3,000	-	3,000
	Torque (Max/Cont.)	N·m(lbf·ft)	-	140/95.4 (103.3/70.4)	-	140/95.4 (103.3/70.4)
	Collet Size	mm(in)	-	Ø34 (1.3") - ER50	-	Ø34 (1.3") - ER50
	Type	-	-	BMT85	-	BMT85
TAIL STOCK	Taper	-	MT6 (Built-in)			
	Quill Dia.	mm(in)	Ø160 (6.3")			
	Quill Travel	mm(in)	132.5 (5.2")			
	Travel	mm(in)	1,580 (62.2")	3,180 (125.2")		
TANK CAPACITY	Coolant Tank	ℓ (gal)	570 (150.6)	770 (203.4)		
	Lubricating Tank	ℓ (gal)	4 (1.1)			
POWER SUPPLY	Electric Power Supply	kVA	50			
	Thickness of Power Cable	Sq	Over 50			
	Voltage	V/Hz	220/60 (200/50*)			
MACHINE	Floor Space (L×W)	mm(in)	7,077×3,075 (278.6"×121.1")	8,715×3,075 (343.1"×121.1")		
	Height	mm(in)	2,700 (106.3")			
	Weight	kg(lb)	18,000 (3,968)	23,500 (51,809)		
NC	Controller	-	FANUC 32i-B [HYUNDAI WIA FANUC i Series - Smart Plus] [HYUNDAI-ITROL]			

\* Prior consultation is required when applying spindle contouring control for gear driven spindle.

\*) Using 50Hz voltage instead of 60Hz may lower the output of motors. (excluding servo motors and inverter motors)

Specifications are subject to change without notice for improvement.

# SPECIFICATIONS

## Specifications

[ ] : Option

ITEM		L700A	L700MA	L700LA	L700LMA	
CAPACITY	Swing Over the Bed	mm(in) Ø1,050 (41.3")				
	Swing Over the Carriage	mm(in) Ø820 (32.3")				
	Max. Turning Dia.	mm(in) Ø920 (36.2")				
	Max. Turning Length	mm(in) 1,650 (65")		mm(in) 3,250 (128")		
	Bar Capacity	mm(in) Ø165 (6.5")				
SPINDLE	Chuck Size	inch Opt. [ 24" ]				
	Spindle Bore	mm(in) Ø181 (7.1")				
	Spindle Speed (rpm)	r/min 1,500				
	Motor (30min./Cont.)	kW(HP) 45/37 (60/50)				
	Torque (30min./Cont.)	N·m(lbf·ft) 6,928/5,700 (5,109.8/4,204.1)				
	Spindle Type	- BELT+3STEP GEAR				
	Spindle Nose	- A1-15				
	C-axis Indexing	deg	-	0.001°	-	0.001°
	FEED	Travel (X/Z)	mm(in) 500/1,680 (19.7"/66.1")		mm(in) 500/3,280 (19.7"/129.1")	
Rapid Traverse Rate (X/Z)		m/min 12/16		m/min 12/12		
Slide Type		- BOX GUIDE				
TURRET	No. of Tools	EA 12				
	Tool Size	OD	mm(in) □ 32 (1.3")			
		ID	mm(in) Ø80 (3.1")			
	Indexing Time	sec/step 0.4				
LIVE TOOL	Motor (Max/Cont.)	kW(HP)	-	11/7.5 (14.8/10)	-	11/7.5 (14.8/10)
	Milling Tool Speed (rpm)	r/min	-	3,000	-	3,000
	Torque (Max/Cont.)	N·m(lbf·ft)	-	140/95.4 (103.3/70.4)	-	140/95.4 (103.3/70.4)
	Collet Size	mm(in)	-	Ø34 (1.3") - ER50	-	Ø34 (1.3") - ER50
	Type	-	-	BMT85	-	BMT85
TAIL STOCK	Taper	- MT6 (Built-in)				
	Quill Dia.	mm(in) Ø160 (6.3")				
	Quill Travel	mm(in) 132.5 (5.2")				
	Travel	mm(in) 1,580 (62.2")		mm(in) 3,180 (125.2")		
TANK CAPACITY	Coolant Tank	ℓ (gal) 570 (150.6)		ℓ (gal) 770 (203.4)		
	Lubricating Tank	ℓ (gal) 4 (1.1)				
POWER SUPPLY	Electric Power Supply	kVA 51				
	Thickness of Power Cable	Sq Over 50				
	Voltage	V/Hz 220/60 (200/50*)				
MACHINE	Floor Space (L×W)	mm(in) 7,077×3,075 (278.6"×121.1")		mm(in) 8,715×3,075 (343.1"×121.1")		
	Height	mm(in) 2,700 (106.3")				
	Weight	kg(lb) 18,000 (3,968)		kg(lb) 23,500 (51,809)		
PC	Controller	- FANUC 32i-B [HYUNDAI WIA FANUC i Series - Smart Plus] [HYUNDAI-ITROL]				

\* Prior consultation is required when applying spindle contouring control for gear driven spindle.

\*) Using 50Hz voltage instead of 60Hz may lower the output of motors. (excluding servo motors and inverter motors)  
Specifications are subject to change without notice for improvement.



# SPECIFICATIONS

## Specifications

[ ] : Option

ITEM			L800A	L800MA	L800LA	L800LMA
CAPACITY	Swing Over the Bed	mm(in)	Ø1,050 (41.3")			
	Swing Over the Carriage	mm(in)	Ø820 (32.3")			
	Max. Turning Dia.	mm(in)	Ø920 (36.2")			
	Max. Turning Length	mm(in)	1,650 (65")		3,250 (128")	
	Bar Capacity	mm(in)	Hydraulic : Ø239 (9.4"), Air/Independent : Ø319 (12.6")			
SPINDLE	Chuck Size	inch	Opt. [32"]			
	Spindle Bore	mm(in)	Ø320 (12.6")			
	Spindle Speed (rpm)	r/min	700			
	Motor (30min./Cont.)	kW(HP)	45/37 (60/50)			
	Torque (30min./Cont.)	N·m(lbf·ft)	7,045/5,795 (5,196.1/4,274.2)			
	Spindle Type	-	BELT+2STEP GEAR			
	Spindle Nose	-	A1-20			
	C-axis Indexing	deg	-	0.001°	-	0.001°
FEED	Travel (X/Z)	mm(in)	500/1,680 (19.7"/66.1")		500/3,280 (19.7"/129.1")	
	Rapid Traverse Rate (X/Z)	m/min	12/16		12/12	
	Slide Type	-	BOX GUIDE			
TURRET	No. of Tools	EA	12			
	Tool Size	OD	□ 32 (1.3")			
		ID	Ø80 (3.1")			
	Indexing Time	sec/step	0.4			
LIVE TOOL	Motor (Max/Cont.)	kW(HP)	-	11/7.5 (14.8/10)	-	11/7.5 (14.8/10)
	Milling Tool Speed (rpm)	r/min	-	3,000	-	3,000
	Torque (Max/Cont.)	N·m(lbf·ft)	-	140/95.4 (103.3/70.4)	-	140/95.4 (103.3/70.4)
	Collet Size	mm(in)	-	Ø34 (1.3") - ER50	-	Ø34 (1.3") - ER50
	Type	-	-	BMT85	-	BMT85
TAIL STOCK	Taper	-	MT6 (Built-in)			
	Quill Dia.	mm(in)	Ø160 (6.3")			
	Quill Travel	mm(in)	132.5 (5.2")			
	Travel	mm(in)	1,580 (62.2")		3,180 (125.2")	
TANK CAPACITY	Coolant Tank	ℓ (gal)	570 (150.6)		770 (203.4)	
	Lubricating Tank	ℓ (gal)	4 (1.1)			
POWER SUPPLY	Electric Power Supply	kVA	54			
	Thickness of Power Cable	Sq	Over 50			
	Voltage	V/Hz	220/60 (200/50*)			
MACHINE	Floor Space (L×W)	mm(in)	7,077×3,075 (278.6"×121.1")		8,715×3,075 (343.1"×121.1")	
	Height	mm(in)	2,700 (106.3")			
	Weight	kg(lb)	18,000 (3,968)		23,500 (51,809)	
NC	Controller	-	FANUC 32i-B [HYUNDAI WIA FANUC i Series - Smart Plus] [HYUNDAI-ITROL]			

\* Prior consultation is required when applying spindle contouring control for gear driven spindle.

\*) Using 50Hz voltage instead of 60Hz may lower the output of motors. (excluding servo motors and inverter motors)  
Specifications are subject to change without notice for improvement.

# SPECIFICATIONS

## Specifications

[ ] : Option

ITEM		L800D	L800MD	L800LD	L800LMD	
CAPACITY	Swing Over the Bed	mm(in)	Ø1,050 (41.3")			
	Swing Over the Carriage	mm(in)	Ø820 (32.3")			
	Max. Turning Dia.	mm(in)	Ø920 (36.2")			
	Max. Turning Length	mm(in)	1,650 (65")	3,250 (128")		
	Bar Capacity	mm(in)	Ø374 (14.7")			
SPINDLE	Chuck Size	inch	Opt. [34" Air Chuck] [32" Independent Chucks]			
	Spindle Bore	mm(in)	Ø375 (14.8")			
	Spindle Speed (rpm)	r/min	500			
	Motor (30min./Cont.)	kW(HP)	45/37 (60/50)			
	Torque (30min./Cont.)	N·m(lbf·ft)	7,288/5,992 (5,375.4/4,419.5)			
	Spindle Type	-	BELT+2STEP GEAR			
	Spindle Nose	-	A2-20			
	C-axis Indexing	deg	-	0.001°	-	0.001°
	FEED	Travel (X/Z)	mm(in)	500/1,680 (19.7"/66.1")	500/3,280 (19.7"/129.1")	
Rapid Traverse Rate (X/Z)		m/min	12/16	12/12		
Slide Type		-	BOX GUIDE			
TURRET	No. of Tools	EA	12			
	Tool Size	OD	□ 32 (1.3")			
		ID	Ø80 (3.1")			
	Indexing Time	sec/step	0.4			
LIVE TOOL	Motor (Max/Cont.)	kW(HP)	-	11/7.5 (14.8/10)	-	11/7.5 (14.8/10)
	Milling Tool Speed (rpm)	r/min	-	3,000	-	3,000
	Torque (Max/Cont.)	N·m(lbf·ft)	-	140/95.4 (103.3/70.4)	-	140/95.4 (103.3/70.4)
	Collet Size	mm(in)	-	Ø34 (1.3") - ER50	-	Ø34 (1.3") - ER50
	Type	-	-	BMT85	-	BMT85
TAIL STOCK (OPTION)	Taper	-	MT6 (Built-in)			
	Quill Dia.	mm(in)	Ø160 (6.3")			
	Quill Travel	mm(in)	132.5 (5.2")			
	Travel	mm(in)	1,580 (62.2")	3,180 (125.2")		
TANK CAPACITY	Coolant Tank	ℓ (gal)	570 (150.6)	770 (203.4)		
	Lubricating Tank	ℓ (gal)	4 (1.1)			
POWER SUPPLY	Electric Power Supply	kVA	54			
	Thickness of Power Cable	Sq	Over 50			
	Voltage	V/Hz	220/60 (200/50*)			
MACHINE	Floor Space (L×W)	mm(in)	7,077×3,075 (278.6"×121.1")	8,715×3,075 (343.1"×121.1")		
	Height	mm(in)	2,700 (106.3")			
	Weight	kg(lb)	18,000 (3,968)	23,500 (51,809)		
PC	Controller	-	FANUC 32i-B [HYUNDAI WIA FANUC i Series - Smart Plus] [HYUNDAI-ITROL]			

\* Prior consultation is required when applying spindle contouring control for gear driven spindle.

\*) Using 50Hz voltage instead of 60Hz may lower the output of motors. (excluding servo motors and inverter motors)

Specifications are subject to change without notice for improvement.

# CONTROLLER

## FANUC 32i-B

[ ] : Option

Controlled axis / Display / Accuracy Compensation	
Control axes	2 axes (X, Z) / 3 axes (X, Z, C) / 4 axes (X, Z, Y, C) 5 axes (X, Z, B, C, A) / 6 axes (X, Z, Y, B, C, A)
Simultaneously controlled axes	2 axes [Max. 4 axes]
Designation of spindle axes	4 axes (1 path), 6 axes (2 path Total)
Least setting Unit	X, Z, Y, B axes : 0.001 mm (0.0001 inch) C, A axes : 0.001 deg
Least input increment	X, Z, Y, B axes : 0.001 mm (0.0001 inch) C, A axes : 0.001 deg
Inch / Metric conversion	G20 / G21
High response vector control	
Interlock	All axes / Each axis
Machine lock	All axes
Backlash compensation	± 0 ~ 9999 pulses (Rapid traverse / Cutting feed)
Position switch	
LCD / MDI	10.4 inch color LCD
Feedback	Absolute motor feedback
Stored stroke check 1	Over travel
Stored stroke check 2, 3	
PMC axis control	
<b>Operation</b>	
Automatic operation (Memory)	
MDI operation	
DNC operation	Needed DNC software / CF card
Program restart	
Wrong operation prevention	
Program check function	Dry run, Program check
Single block	
Search function	Program Number / Sequence Number
<b>Interpolation functions</b>	
Nano interpolation	
Positioning	G00
Linear interpolation	G01
Circular interpolation	G02, G03
Exact stop mode	Single : G09, Continuous : G61
Dwell	G04, 0 ~ 9999.9999 sec
Skip	G31
Reference position return	1st reference : G28 2nd reference : G30 Ref. position check : G27
Thread synchronous cutting	
Thread cutting retract	
Variable lead thread cutting	
Multi / Continuous threading	
<b>Feed function / Acc. &amp; Dec. control</b>	
Manual feed	Rapid traverse Jog : 0~2,000 mm/min (79 ipm) Manual handle : x1, x10, x100 pulses Reference position return
Cutting Feed command	Direct input F code
Feedrate override	0 ~ 200% (10% Unit)
Rapid traverse override	F1%, F25%, 50%, F100%
Override cancel	
Feed per minute	G98
Feed per revolution	G99
Look-ahead block	1 block
<b>Program input</b>	
Tape Code	EIA / ISO
Optional block skip	1 ea
Program stop / end	M00, M01 / M02, M30
Maximum command unit	± 999,999,999 mm (± 99,999,999 inch)
Plane selection	X-Y : G17 / Z-X : G18 / Y-Z : G19
Workpiece coordinate system	G52, G53, 6 pairs (G54 ~ G59)
Manual absolute	Fixed ON
Programmable data input	G10
Sub program call	10 folds nested
Custom macro	#100 ~ #149, #500 ~ #549
G code system	A
Programmable mirror image	G51.1, G50.1
G code preventing buffering	G4.1
Multiple repetitive cycles I, II	
<b>Program input</b>	

Canned cycle for turning	
Manual Guide i	Conversational auto program
<b>Auxiliary function / Spindle speed function</b>	
Auxiliary function	M 4 digit
Level-up M Code	High speed / Multi / Bypass M code
Spindle speed function	S 4 digit, Binary output
Spindle override	0% ~ 150% (10% Unit)
Multi position spindle orientation	M19
Rigid tapping	
Constant surface speed control	G96, G97
<b>Tool function / Tool compensation</b>	
Tool function	T 2 digit + Offset 2 digit
Tool life management	
Tool offset pairs	32 pairs
Tool nose radius compensation	G40, G41, G42
Geometry / Wear compensation	
Direct input of offset measured B	
<b>Editing function</b>	
Part program storage size	640m (256KB)
No. of registerable programs	500 ea
Program protect	
Background editing	
Extended part program editing	Copy, move and change of NC program
Memory card program edit	
<b>Data input / output &amp; Interface</b>	
I/O interface	RS 232C serial port, CF card, USB memory Embedded Ethernet interface
Screen hard copy	
External message	
External key input	
External workpiece number search	
Automatic data backup	
<b>Setting, display and diagnosis</b>	
Self-diagnosis function	
History display & Operation	Alarm & Operator message & Operation
Run hour / Parts count display	
Maintenance information	
Actual cutting feedrate display	
Display of spindle speed / T code	
Graphic display	
Operating monitor screen	Spindle / Servo load etc.
Power consumption monitoring	Spindle & Servo
Spindle / Servo setting screen	
Multi language display	Support 20 languages
Display language switching	Selection of 5 optional Languages
LCD Screen Saver	Screen saver
Unexpected disturbance torque	BST (Back spin torque limit)
<b>Function for machine type</b>	
Cs contour control (C & A axes)	Mill, MS, Y, SY, LF-Mill, TTMS, TTSY
Polar coordinate interpolation	Mill, MS, Y, SY, LF-Mill, TTMS, TTSY
Cylindrical interpolation	Mill, MS, Y, SY, LF-Mill, TTMS, TTSY
Canned cycle for drilling	Mill, MS, Y, SY, LF-Mill, TTMS, TTSY
Spindle orientation expansion	MS, SY TTS, TTMS, TTSY
Spindle synchronous control	MS, SY TTS, TTMS, TTSY
Torque control	MS, SY TTS, TTMS, TTSY
Y axis offset	Y, SY, TTSY
Arbitrary angular control	Y, SY, TTSY
Composite / Superimposed control	MS, SY TTS, TTMS, TTSY
Balance cutting	MS, SY TTS, TTMS, TTSY
<b>Option</b>	
Additional optional block skip	9 ea
Fast ethernet	Needed option board
Data server	Needed option board
Protection of data at 8 levels	
Tool offset pairs	64 pairs / 99 pairs / 200 pairs
Part program storage size	1280 m (512KB) / 2560m (1MB)
Polygon turning (2 Spindles)	Mill, MS, Y, SY, LF-Mill, TTMS, TTSY
Helical interpolation	
Dynamic graphic display	
Direct drawing dimension program	Including Chamfering / Corner R

Figures in inch are converted from metric values.

The FANUC controller specifications are subject to change based on the policy of company CNC supplying.

## HYUNDAI WIA FANUC i Series – Smart Plus

[ ] : Option

Controlled axis / Display / Accuracy Compensation	
Control axes	2 axes (X, Z) / 3 axes (X, Z, C) / 4 axes (X,Z,Y,C) 5 axes (X, Z, B, C, A) / 6 axes (X, Z, Y, B, C, A) 7 axes (X1/Z1, X2/Z2, B2, C1/C2)
Simultaneously controlled axes	2 axes [Max. 4 axes]
Designation of spindle axes	3 axes [Max. 4 axes]
Least setting Unit	X, Z, Y, B axes : 0.001 mm (0.0001 inch) C, A axes : 0.001 deg
Least input increment	X, Z, Y, B axes : 0.001 mm (0.0001 inch) C, A axes : 0.001 deg
Inch / Metric conversion	G20 / G21
High response vector control	
Interlock	All axes / Each axis
Machine lock	All axes
Backlash compensation	± 0~9999 pulses (exc. Rapid traverse / Cutting feed)
Position switch	
LCD / MDI	15 inch LCD unit (with Touch Panel)
Feedback	Absolute motor feedback
Stored stroke check 1	Over travel
Stored stroke check 2, 3	
PMC axis control	
Operation	
Automatic operation (Memory)	
MDI operation	
DNC operation	Needed DNC software / CF card
Program restart	
Wrong operation prevention	
Program check function	Dry run
Single block	
Search function	Program Number / Sequence Number
Interpolation functions	
Nano interpolation	
Positioning	G00
Linear interpolation	G01
Circular interpolation	G02, G03
Exact stop mode	Single : G09, Continuous : G61
Dwell	G04, 0 ~ 9999.9999 sec
Skip	G31
Reference position return	1st reference : G28, 2nd reference : G30 Ref. position check : G27
Thread synchronous cutting	G33
Thread cutting retract	
Variable lead thread cutting	
Multi / Continuous threading	
Feed function / Acc. & Dec. control	
Manual feed	Rapid traverse Jog : 0~2,000 mm/min (79 ipm) Manual handle : x1, x10, x100 pulses Reference position return
Cutting Feed command	Direct input F code
Feedrate override	0 ~ 200% (10% Unit)
Rapid traverse override	1%, F25%, 50%, 100%
Override cancel	
Feed per minute	G98
Feed per revolution	G99
Look-ahead block	1 block
Program input	
Tape Code	EIA / ISO
Optional block skip	9 ea
Program stop / end	M00, M01 / M02, M30
Maximum command unit	± 999,999.999 mm (± 99,999.9999 inch)
Plane selection	X-Y : G17 / Z-X : G18 / Y-Z : G19
Workpiece coordinate system	G52, G53, 6 pairs (G54 ~ G59)
Manual absolute	Fixed ON
Programmable data input	G10
Sub program call	10 folds nested
Custom macro	#100 ~ #199, #500 ~ #999
G code system	A, B/C
Programmable mirror image	G51.1, G50.1
G code preventing buffering	G4.1
Direct drawing dimension program	Including Chamfering / Corner R
Conversational Program	SmartGuide-i

Program input	
Multiple repetitive cycles	I, II
Canned cycle for turning	
Auxiliary function / Spindle speed function	
Auxiliary function	M & 4 digit
Level-up M Code	High speed / Multi / Bypass M code
Spindle speed function	S & 5 digit, Binary output
Spindle override	0% ~ 150% (10% Unit)
Multi position spindle orientation	M19 (S##)
Rigid tapping	
Constant surface speed control	G96, G97
Tool function / Tool compensation	
Tool function	T & 2 digit + Offset 2 digit
Tool life management	
Tool offset pairs	128 pairs
Tool nose radius compensation	G40, G41, G42
Geometry / Wear compensation	
Direct input of offset measured B	
Editing function	
Part program storage size	5,120m (2MB)
No. of registerable programs	1,000 ea
Program protect	
Background editing	
Extended part program editing	Copy, move and change of NC program
Memory card program edit	
Data input / output & Interface	
I/O interface	CF card, USB memory Embedded Ethernet interface
Screen hard copy	
External message	
External key input	
External workpiece number search	
Automatic data backup	
Setting, display and diagnosis	
Self-diagnosis function	
History display & Operation	Alarm & Operator message & Operation
Run hour / Parts count display	
Maintenance information	
Actual cutting feedrate display	
Display of spindle speed / T code	
Graphic display	
Operating monitor screen	Spindle / Servo load etc.
Power consumption monitoring	Spindle & Servo
Spindle / Servo setting screen	
Multi language display	Support 24 languages
Display language switching	Selection of 5 optional Languages
LCD Screen Saver	Screen saver
Unexpected disturbance torque	BST (Back spin torque limit)
Function for machine type	
Cs contour control (C & A axes)	Mill, MS, Y, SY, LF-Mill, TTMS, TTSY
Polar coordinate interpolation	Mill, MS, Y, SY, LF-Mill, TTMS, TTSY
Cylindrical interpolation	Mill, MS, Y, SY, LF-Mill, TTMS, TTSY
Polygon turning (2 Spindles)	Mill, MS, Y, SY, LF-Mill, TTMS, TTSY
Canned cycle for drilling	Mill, MS, Y, SY, LF-Mill, TTMS, TTSY
Spindle orientation expansion	MS, SY, TTS, TTMS, TTSY
Spindle synchronous control	MS, SY, TTS, TTMS, TTSY
Torque control	MS, SY, TTS, TTMS, TTSY
Y axis offset	Y, SY, TTSY
Arbitrary angular control	Y, SY, TTSY
Composite / Superimposed control	MS, SY, TTS, TTMS, TTSY
Balance cutting	TTS, TTMS, TTSY
Option	
Fast ethernet	Needed option board
Data server	Needed option board
Protection of data at 8 levels	
Tool offset pairs	200 pairs
Helical interpolation	
Optional block skip	40 ea, 200 ea (AICC II)

Figures in inch are converted from metric values.

The FANUC controller specifications are subject to change based on the policy of company CNC supplying.

# CONTROLLER

## HYUNDAI-iTROL (SIEMENS 828D)

[ ] : Option ☆ Needed technical consultation

Controlled axis / Display / Accuracy Compensation	
Control axes	2 axes (X, Z) - Std.
	3 axes (X, Z, C) - Mill
	4 axes (X, Z, Y, C) - Y
	5 axes (X, Z, B, C, A) - MS
	6 axes (X, Z, Y, B, C, A) - SY
	Max. 4 axes
Simultaneously controlled axes	Max. 4 axes
Least setting Unit	X, Z, Y, B axes : 0.001 mm (0.0001 inch)
	C, A axes : 1 deg [0.001] deg
Least input increment	X, Z, Y, B axes : 0.001 mm (0.0001 inch)
	C, A axes : 1 deg [0.001] deg
Inch / Metric changeover	G70 (inch) / G71 (metric)
Interlock	All axes / Each axis
Backlash compensation	
Pitch error compensation	Leadscrew pitch error compensation
LCD / MDI	10.4 inch color LCD
	[15 inch color LCD (With Touch panel)]
Keyboard	QWERTY full keyboard
Stored stroke check	Over travel
Operation	
Automatic operation	
MDI operation	
Program restart	
Program check function	Dry run / Program check / Machine lock
Single block	
Block search	Block search
Reposition	
Working area limit	Working area limitations
Interpolation functions	
Positioning	G00
Linear interpolation	G01
Circular interpolation	Circular interpolation CW (G02)
	Circular interpolation CCW (G03)
	Single block exact stop (G09)
Exact position stop	Exact stop G60 (G601, G602, G603)
Dwell	Dwell (G04)
Reference position return	Return to reference point
	Return to 2nd reference point
Helical interpolation	
Thread synchronous cutting	
Thread cutting retract	
Spline interpolation	Non-uniform rational B splines
Feed function / Acc. & Dec. control	
Manual feed	Rapid traverse
	Jog
	Manual handle
	Reference position return
Cutting Feed command	Direct input F code
Feedrate override	0 ~ 200% (10% Unit)
Rapid traverse override	1%, 25%, 50%, 100%
Feed per minute	G94
Feed per revolution	G95
Look-ahead block	1 block
Program input	
ISO support	G291 (ISO) / G290 (SIEMENS)
	(ISO G Code system-A)
Optional block skip	2
Program stop / end	M00, M01 / M02, M30
Maximum command unit	± 999,999.999 mm, ± 99,999.9999 inch
Plane selection	X-Y : G17, X-Z : G18, Y-Z : G19
	G54 ~ G57, G505~G549
Workpiece coordinate system	G500 (Basic frame - settable zero offset)
	G53 (Work offset non modal)
	G153 (basic frame non modal)
Sub program call	11 folds nested
G code preventing buffering	STOPRE
Turning Cycle	Turning programing (Cycle 93, 94, 95, 97)
User Cycle	

Auxiliary function / Spindle speed function	
Auxiliary function	M Code 4 digit
Spindle speed function	S Code 5 digit
Spindle override	0% ~ 150% (10% Unit)
Spindle orientation	SPOS
Rigid tapping	
Automatic mode interchange	Spindle / Axis mode
Constant surface speed control	G96, G97
Spindle speed limitation	LIMS
Tool function / Tool compensation	
Tool function	Tool number & Tool name
	Tool : T + Offset : D
Tool life management	128 ea : Std.
	256 ea : Mill
	768 ea : Y, MS, SY
Cutting Edges in tool list	256 ea : Std.
	512 ea : Mill
Tool nose radius compensation	1,536 ea : Y, MS, SY
	ISO (G40, G41, G42)
Geometry / Wear compensation	
Measurement of tool length	
Tool management function	
Editing function	
Part program storage size	3MB - Std.
	5MB - Mill
No. of registerable programs	10MB - Y, MS, SY
	750 ea
External Storage devices	Local network, Server, USB, Flash drive
Background editing	
Extended part program editing	Copy, move and change of NC program
Memory card program edit	
Data input / output & Interface	
I/O interface	CF card interface (ONLY 10.4")
	USB memory interface
	Embedded Ethernet memory interface
Screenshot	
Setting, display and diagnosis	
Self-diagnosis function	
History display & Operation	Alarm & Operator message & Operation
Run hour / Parts count display	
Maintenance information	
Actual cutting feedrate display	
Display of spindle speed / T code	
Graphic display	
Operating monitor screen	Spindle / Servo load etc.
	Support 9 languages
Multi language display	Chinese (Simplified/Traditional), English, French, German, Italian, Korean, Portuguese, Spanish
	[☆ Support 22 languages : Inquiry need]
LCD Screen Saver	Screen saver & Motion sensing
Function for machine type	
Cs contour control (C & A axes)	Mill, MS, Y, SY model
Polar coordinate interpolation	Mill, MS, Y, SY model
Cylindrical interpolation	Mill, MS, Y, SY model
Canned cycle for drilling	Mill, MS, Y, SY model
[Polygon turning (CP-Basic)]	Mill, MS, Y, SY model
[Hobbing / Skybing (CP-Comfort)]	Mill, MS, Y, SY model
Spindle synchronous control	MS, SY model
Servo tailstock function	MS, SY model
Option	
Additional optional block skip	10
Contour handwheel	
3D simulation	
Real time simulation	
Shop Turn	Machining step programming for turning



# HW-MMS

HYUNDAI WIA Machine Monitoring System



A manufacturing machine self-developed by Hyundai Wia, HW-MMS is a unique software capable of monitoring the operation status of manufacturing machines in factories, a smart solution to improve manufacturing conditions of customers

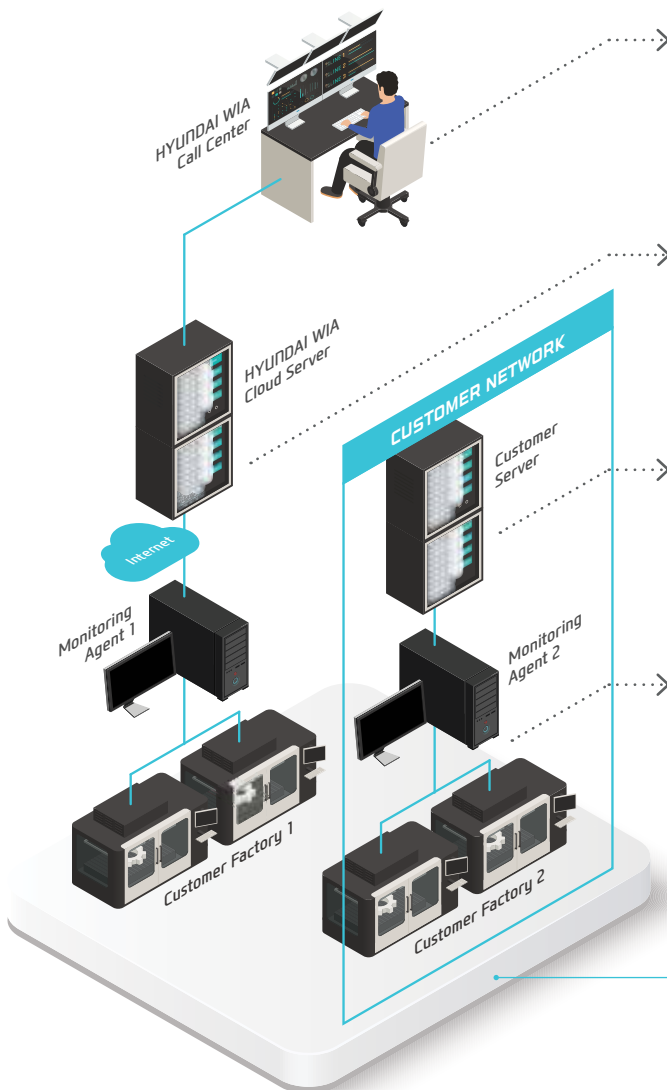

**HW-MMS Remote**  
Hyundai Wia Call Center's remote diagnosis service provides a HMI/video diagnostic function.



**HW-MMS Cloud**  
A cloud server-based equipment monitoring system for collecting and analyzing facility operation data.



**HW-MMS Edge**  
A client server-based tool monitoring system for collection/analysis of facility operation data. (Compatible with client MES / ERP interface)



**HW-MMS Edge Plus**  
This is a facility big data-based smart factory solution that collects and analyzes spindle/feed data, tool lifespan, PC processing files, etc. in real time

HYUNDAI WIA  
Smart Factory Solution



L700A  
Movie



L800D  
Movie 1



L800D  
Movie 2



**You Tube** HYUNDAI WIA MT

[www.youtube.com/HYUNDAIWIAMT](http://www.youtube.com/HYUNDAIWIAMT)

## EXPERIENCE THE NEW TECHNOLOGY

With its top-quality HYUNDAI WIA machine tool creates a new and better world.



<http://machine.hyundai-wia.com>

HYUNDAI WIA Machine Tools  
Global Links

### HEADQUARTER

**Changwon Technical Center/R&D Center/Factory** 153, Jeongdong-ro, Seongsan-gu, Changwon-si, Gyeongsangnam-do, Korea TEL : +82 55 280 9114 FAX : +82 55 282 9114

**Overseas Sales Team /R&D Center** 37, Cheoldobangmulgwan-ro, Uiwang-si, Gyeonggi-do, Korea TEL : +82 31 8090 2539

### OVERSEAS OFFICES

**HYUNDAI WIA Machine America corp.** 450 Commerce Blvd, Carlstadt, NJ 07072, USA TEL : +1-201-987-7298

**HYUNDAI WIA Europe GmbH** Alexander-Fleming-Ring 57, 65428 Rüsselsheim Germany TEL : +49-0-6142-9256-0

**HYUNDAI WIA Machine Tools China** 2-3F, Bldg6, No.1535 Hongmei Road, Xuhui District, Shanghai, China TEL : +86-21-6427-9885

**India Branch Office** #4/169, 1st Floor, LOTTE BLDG, Rajiv Gandhi Salai, (OMR), Kandanchavadi, Chennai - 600096, Tamilnadu, India TEL : +91-76-0490-3348

**Vietnam Branch Office** Flat number 05, Service and Trade Center of Viet Huong Industrial Zone, Highway 13, Thuan Giao, Thuan An, Binh Duong, Vietnam TEL : +84-3-5399-5099