











700x750 HERKULES X-CNC

 mm	 mm	 a b a x b	 a b a x b
700	700	750x700	750x450

	 kW	 m/min	 mm	 kg	
3x400 V	11,0	15 - 80	7680x67x1,6	10 000	
Lmin	Lmax	B	Hmin	Hmax	V
4320	5640	2480	2270	2750	615

* doporučená hodnota. Při překročení doporučeného maximálního průměru není možné garantovat výkon pilového pásu!
/recommended value. The blade performance cannot be guaranteed when the recommended diameter is exceeded!

 a x b - řezání svazků bez horního přitlaku / cutting of the bundle without top clamping/

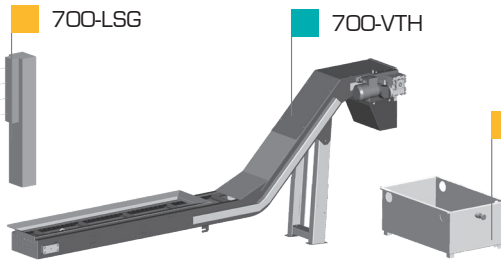
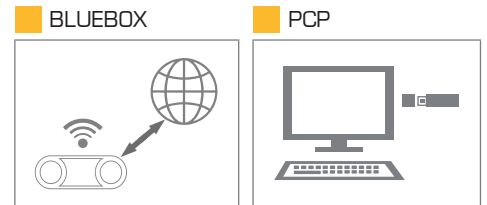
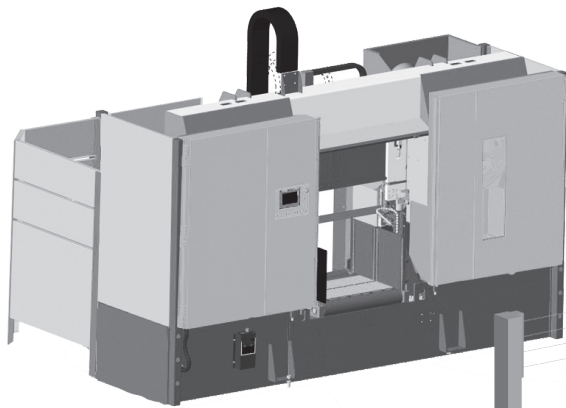
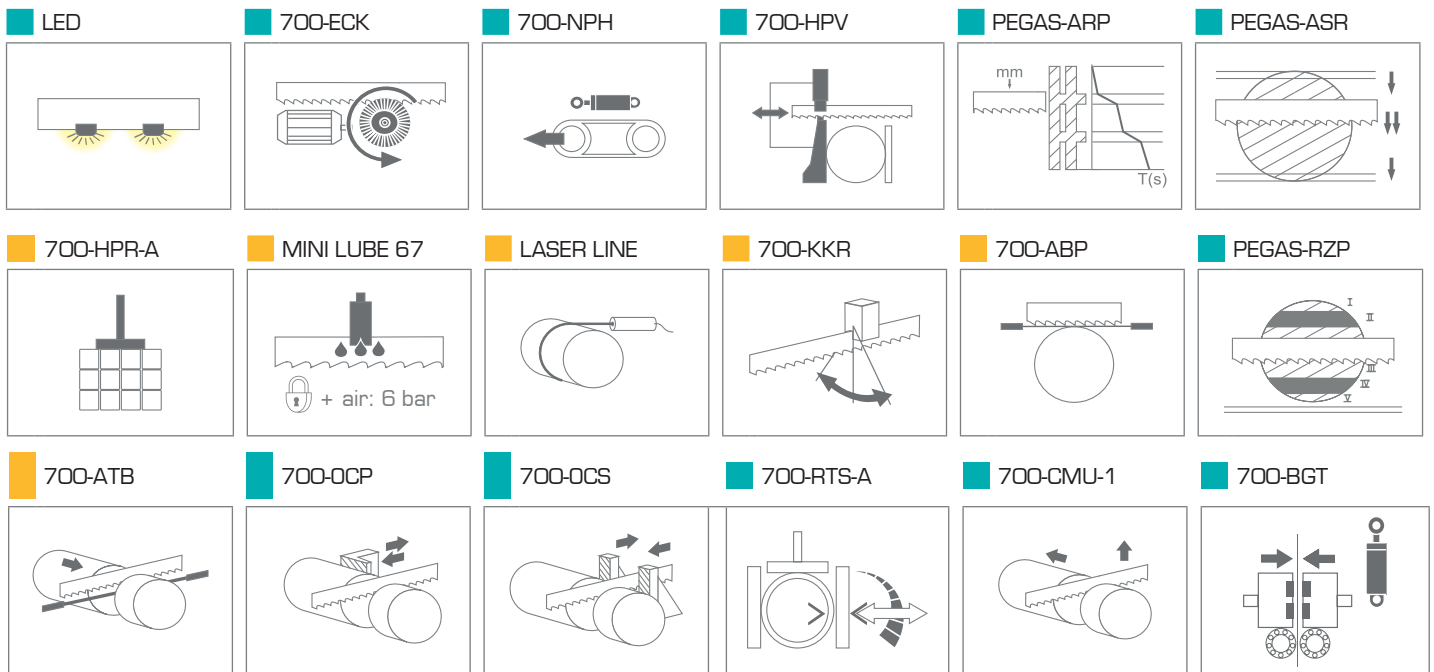

BOX-TRI-BIG

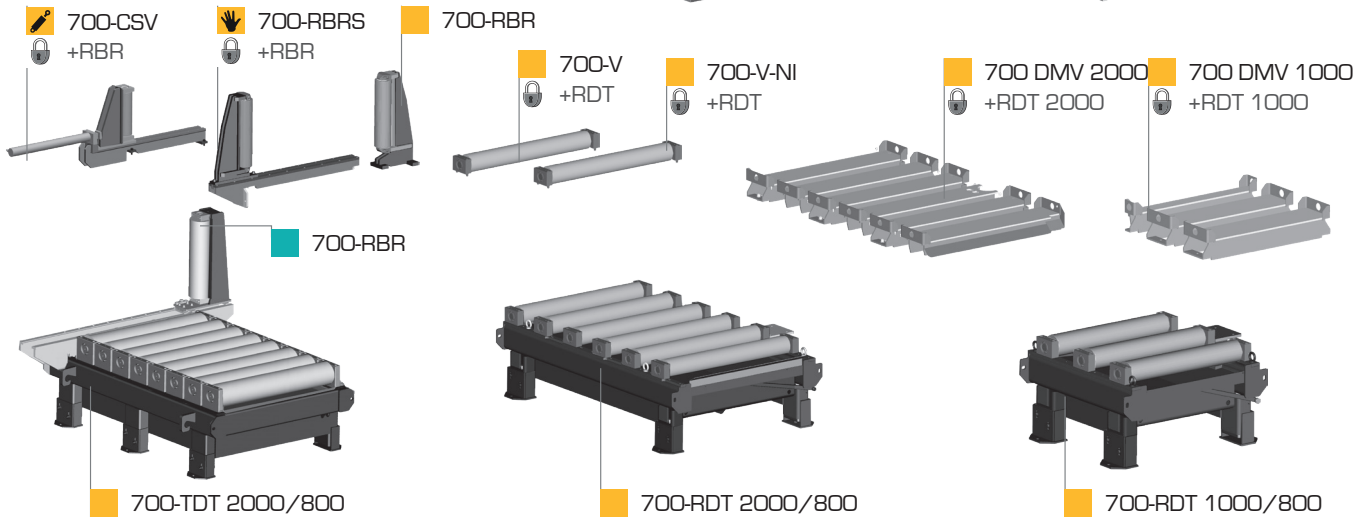

700x750 HERKULES X-CNC

■ STANDARD ■ OPTION



PEGAS-GONDA s.r.o., Čs.armády 322, 684 01 Slavkov u Brna, CZECH REPUBLIC
Tel: 00420-544 221 125 (126), Fax: 00420-544 227 389, E-mail: pegas@gonda.cz
www.pegas-gonda.cz

- výrobce si vyhrazuje právo provádět změny technických údajů, technické údaje odpovídají 1.3.2018
/ producer has the right to make changes of technical data, technical data are valid on 1.3.2018 /
- pila na fotografii není vždy v základním provedení, uvedené rozměry odpovídají stroji v základním provedení
/ the machine in the picture is not always in the basic version, mentioned diameters are for machine in basic version /

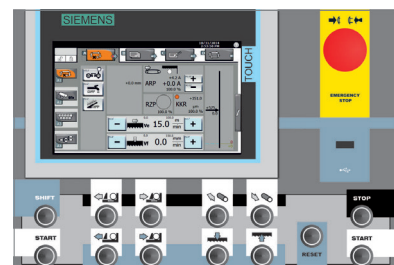

CONTROL PANEL: SIEMENS (X-CNC)